



Scan the QR code to see the manual.



OWNER'S MANUAL

AIR CONDITIONER



In order to use the product safely and conveniently, please read the owner's manual before using the product.

ENGLISH

TYPE: WALL MOUNTED



MFL72096402
Rev.01_111324

www.lg.com

Copyright © 2017-2024 LG Electronics. All Rights Reserved.

TABLE OF CONTENTS

This manual may contain images or content that may be different from the model you purchased.
This manual is subject to revision by the manufacturer.

SAFETY INSTRUCTIONS

READ ALL INSTRUCTIONS BEFORE USE..... 3
WARNING INSTRUCTIONS 4
CAUTION INSTRUCTIONS 9

OPERATION

Before Use 11
Product Overview..... 12
Preparation before Operation..... 13
Wireless Remote Control Overview 15
Using Wireless Remote Control 19
Additional Features and Settings 35
Display Overview..... 45
Using the Power Button 49

SMART FUNCTIONS

LG ThinQ Application 51
Diagnosis Using LG ThinQ 52

MAINTENANCE

Cleaning Function 54
Cleaning 57

TROUBLESHOOTING

Before Calling for Service..... 67

SAFETY INSTRUCTIONS

READ ALL INSTRUCTIONS BEFORE USE

The following safety guidelines are intended to prevent unforeseen risks or damage from unsafe or incorrect operation of the appliance. The guidelines are separated into 'WARNING' and 'CAUTION' as described below.

Safety Messages



This symbol is displayed to indicate matters and operations that can cause risk.

Read the part with this symbol carefully and follow the instructions in order to avoid risk.



WARNING

This indicates that the failure to follow the instructions can cause serious injury or death.



CAUTION

This indicates that the failure to follow the instructions can cause the minor injury or damage to the product.

Notes for Flammable Refrigerant

The following symbols are displayed on units.



This symbol indicates that this appliance uses a flammable refrigerant. If the refrigerant is leaked and exposed to an external ignition source, there is a risk of fire.



This symbol indicates that the Owner's Manual should be read carefully.



This symbol indicates that service personnel should be handling this equipment with reference to the Installation Manual.



This symbol indicates that information is available in the Owner's Manual or Installation Manual.

WARNING INSTRUCTIONS

WARNING

- To reduce the risk of explosion, fire, death, electric shock, injury or scalding to persons when using this product, follow basic precautions, including the following:

Technical Safety

- This appliance can be used by children aged from 8 years and above and persons with reduced physical, sensory or mental capabilities or lack of experience and knowledge if they have been given supervision or instruction concerning use of the appliance in a safe way and understand the hazards involved. Children shall not play with the appliance. Cleaning and user maintenance shall not be made by children without supervision.
- This appliance is not intended for use by persons (including children) with reduced physical, sensory or mental capabilities, or lack of experience and knowledge, unless they have been given supervision or instruction concerning use of the appliance by a person

responsible for their safety. Children should be supervised to ensure that they do not play with the appliance.

- Installation or repairs made by unauthorized persons can pose hazards to you and others.
- The information contained in the manual is intended for use by a qualified service technician who is familiar with the safety procedures and equipped with the proper tools and test instruments.
- Failure to read and follow all instructions in this manual can result in equipment malfunction, property damage, personal injury and/or death.
- The refrigerant and insulation blowing gas used in the appliance require special disposal procedures. Consult a service agent or a similarly qualified person before disposing of them.
- When the power cord is to be replaced, the replacement work shall be performed by authorized personnel using only genuine replacement parts.
- If the supply cord is damaged, it must be replaced by the manufacturer, its service agent or similarly qualified person in order to avoid a hazard.
- The appliance shall be installed in accordance with national wiring regulations.
- Means for disconnection must be incorporated in the fixed wiring in accordance with the wiring rules.
- This appliance must be properly grounded to minimize risk of electric shock.
- Do not cut or remove the grounding prong from the power plug.
- Attaching the earth wire to the power outlet cover screw does not ground the appliance unless the cover screw is metal, uninsulated, and the power outlet is grounded through house wiring.
- If you have any doubt whether the air conditioner is properly grounded, have the power outlet and circuit checked by a qualified electrician.

Installation

- Contact an authorized service centre when installing or relocating the air conditioner.
- Do not install the air conditioner on an unstable surface or in a place where there is danger of it falling.
- Do not install the unit in potentially explosive atmospheres.
- Do not install the air conditioner in a place where flammable liquids or gases such as gasoline, propane, paint thinner, etc., are stored.
- Install the panel and the cover of the control box safely.
- Install a dedicated electric outlet and circuit breaker before using the air conditioner.
- Use standard circuit breaker and fuse that conform to the rating of the air conditioner.
- Make sure that the pipe and the power cable connecting the indoor and outdoor units are not pulled too tight when installing the air conditioner.
- The indoor/outdoor wiring connections must be secured tightly, and the cable should be routed properly so that there is no force pulling the cable from the connection terminals. Improper or loose connections can generate heat or cause a fire.
- Do not connect the ground wire to a gas pipe, a lightning rod, or a telephone ground wire.
- Use non-flammable gas (nitrogen) to check for leaks and to purge air; using compressed air or flammable gas may cause fire or explosion.

Operation

- Do not modify or extend the power cable. Scratches or peeling insulation on the power cables may result in fire or electric shock, and should be replaced.
- Make sure that the power cable is neither dirty, loose, nor broken.
- Do not place any objects on the power cable.
- Do not place a heater or other heating appliances near the power cable.

- Take care to ensure that the power cable could not be pulled out or damaged during operation.
- Never touch, operate, or repair the air conditioner with wet hands.
- Do not insert hands or other objects through the air inlet or outlet while the air conditioner is operating.
- Make sure that children do not climb on or hit the outdoor unit.
- Be sure to use only those parts listed in the service parts list. Never attempt to modify the equipment.
- Do not touch the refrigerant pipe, water pipe or any internal parts while the unit is operating or immediately after operation.
- Do not leave flammable substances such as gasoline, benzene, or thinner near the air conditioner.
- Do not use the air conditioner for an extended period of time in a small place without proper ventilation.
- Be sure to ventilate sufficiently when the air conditioner and a heating appliance such as a heater are used simultaneously.
- Do not block the inlet or outlet of airflow.
- Cut off the power supply if there is any noise, smell, or smoke coming from the air conditioner.
- Contact an authorized service centre when the air conditioner is submerged by flood waters.
- In the event of a gas leak (such as Freon, propane gas, LP gas, etc.) ventilate sufficiently before using the air conditioner again.
- Cut off the power supply immediately in the event of a blackout or a thunderstorm.

Remote Control

- Remove the batteries if the remote control is not to be used for an extended period of time.
- Never mix different types of batteries, or old and new batteries for the remote control.
- Do not recharge or disassemble the batteries.

- Stop using the remote control if there is a fluid leak in the battery. If your clothes or skin is exposed to the leaking battery fluid, wash off with clean water.
- If the leaking battery fluid has been swallowed, rinse the inside of the mouth thoroughly and consult a doctor.
- Dispose of the batteries in a place where there is no danger of fire.

Maintenance

- Before cleaning or performing maintenance, disconnect the power supply and wait until the fan stops.
- Do not clean the appliance by spraying water directly onto the product.

Refrigerant

General

- Use only the refrigerant specified on the air conditioner label.
- Do not input air or gas into the system except the specified refrigerant.
- Do not touch the leaking refrigerant during installation or repair.
- Be sure to check for refrigerant leaks after installing or repairing the air conditioner.
- The appliance shall be stored so as to prevent mechanical damage from occurring.

R32 Only



- Any person who is involved with working on or breaking into a refrigerant circuit should hold a current valid certificate from an industry-accredited assessment authority, which authorizes their

competence to handle refrigerants safely in accordance with an industry recognized assessment specification.

- Servicing shall only be performed as recommended by the equipment manufacturer. Maintenance and repair requiring the assistance of other skilled personnel shall be carried out under the supervision of the person competent in the use of flammable refrigerants.
- The appliance shall be stored in a well-ventilated area where the room size corresponds to the room area as specified for operation.
- Keep any required ventilation openings clear of obstruction.
- The appliance shall be stored in a room without continuously operating open flames (for example an operating gas appliance) and ignition sources (for example an operating electric heater).

CAUTION INSTRUCTIONS

CAUTION

- To reduce the risk of minor injury to persons, malfunction, or damage to the product or property when using this product, follow basic precautions, including the following:

Installation

- Transport the air conditioner with two or more people or use a forklift.
- Install the outdoor unit such that it is protected from direct sunlight. Do not place the indoor unit in a place where it is directly exposed to sunlight via the windows.
- Do not install the air conditioner in an area where it is directly exposed to sea wind (salt spray).
- Install the drain hose properly for the smooth drainage of water condensation.
- Install the air conditioner in a place where the noise from the outdoor unit or the exhaust fumes will not inconvenience the neighbours. Failure to do so may result in conflict with the neighbours.

- Safely dispose of packing materials such as screws, nails, plastic bags or batteries using proper packaging after installation or repair.
- Exercise caution when unpacking or installing the air conditioner.

Operation

- Make sure that the filter is installed before operating the air conditioner.
- Do not drink the water drained from the air conditioner.
- Do not place any object on the air conditioner.
- Do not let the air conditioner run for a long time when humidity is very high or when a door or a window has been left open.
- Do not expose people, animals, or plants to the cold or hot wind from the air conditioner for extended periods of time.
- Do not use the product for special purposes, such as preserving foods, works of art, etc. the air conditioner is designed for consumer purposes, and is not a precision refrigeration system. There is risk of damage or loss of property.

Maintenance

- Use a sturdy stool or ladder when cleaning, maintaining, or repairing the air conditioner at a height.
- Never use strong cleaning agents or solvents or spray water when cleaning the air conditioner. Use a soft cloth.
- Never touch the metal parts of the air conditioner when removing the air filter.
- To clean the interior, contact an authorized service centre or dealer. Using harsh detergents may cause corrosion or damage to the unit.

OPERATION

Before Use

Notes for Operation

- Adjust the direction of the airflow vertically or horizontally to circulate indoor air.
- Speed up the fan to cool or warm indoor air quickly, within a short period of time.
- Turn off the appliance and periodically open windows for ventilation. The indoor air quality may deteriorate if the appliance is used for long durations.
- Clean the air filter once every 2 weeks. Dust and impurities collected in the air filter may block the airflow or reduce the appliance performance.
- Energy consumption may vary depending on usage and when the LCD display is activated.
- Energy consumption is calculated in accordance with EN 14511:2022, EN 14825:2022 which requires that the LCD display be inactive during testing.

Suggestions for Energy Saving

- Do not over-cool the space. This may be harmful for your health and may consume more electricity.
- Block sunlight with blinds or curtains while you are operating the appliance.
- Keep doors or windows closed tightly while you are operating the appliance.

Product Overview

Wall-Mounted

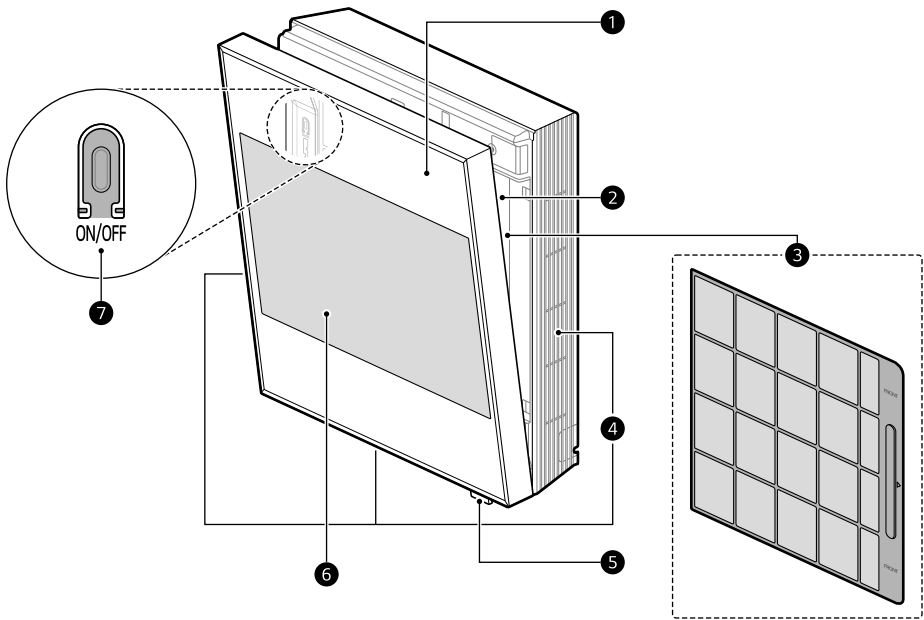

❶ Front Panel

❷ Air Intake Vent

❸ Air Filter

❹ Air Outlet Vents

❺ Status Indicator and Remote Control Receiver (LED)

❻ Display

❼ Power Button

NOTE

- The number and location of parts may vary depending on the model of the appliance.
- Features may change depending on the model type.

Preparation before Operation

Inserting the Batteries into the Wireless Remote Control

Insert AA (1.5 V) batteries into the wireless remote control.

- 1 Remove the battery cover.

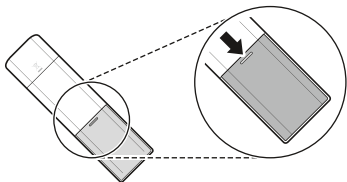

- 2 Insert the new batteries and make sure that the + and - terminals of the batteries are installed correctly.

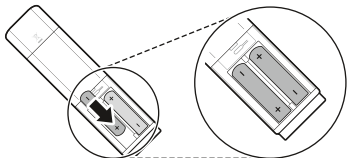

- 3 Reattach the cover by sliding it back into position.

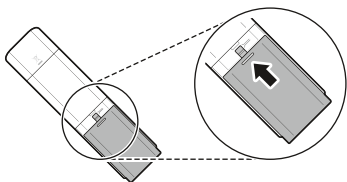

NOTE

- When the wireless remote control display begins to fade, replace AA (1.5 V) batteries.
- Do not use old and new batteries together.

Connecting the Appliance and Remote Control

If **Connection required** appears on the remote control display, connect the appliance and remote control following the method below.

- Press and hold the **Mode** button on the remote control for about 3 seconds. When **Connection successful** appears on the remote control display, the connection between the appliance and the remote control is completed.

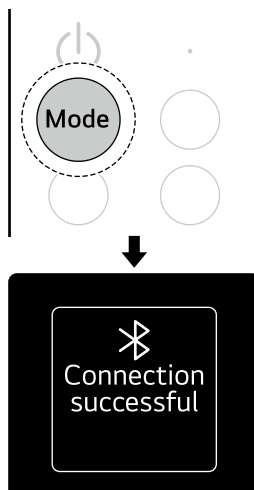

- You can press the **Pointer** button on the remote control and then check the pointer that appears on the screen when you move the remote control.

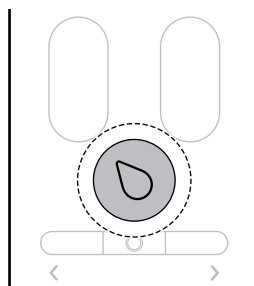

NOTE

- If the appliance and remote control are disconnected due to external factors, reconnect the appliance and remote control to use the appliance smoothly.
 - To adjust the remote control's pointer speed, press the  button at the bottom of the home screen and go to System > Language & Input > Pointer Speed.
-

Wireless Remote Control Overview

Wireless Remote Control

You can operate the appliance more conveniently with the wireless remote control.

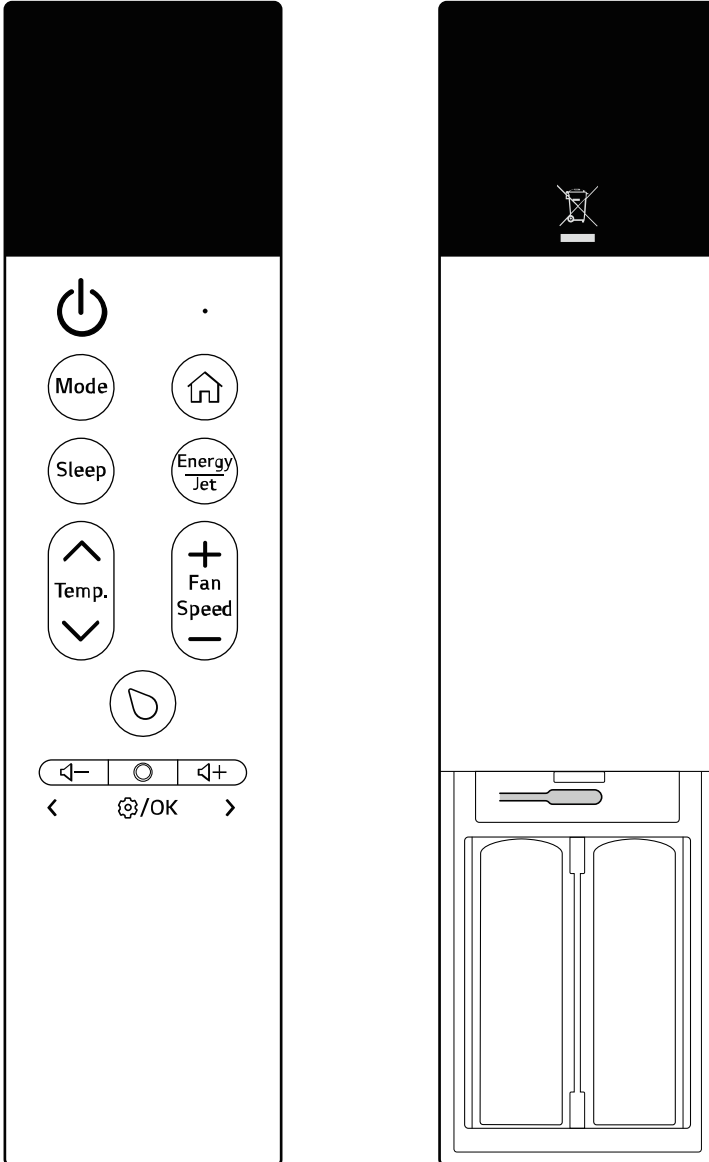









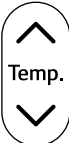







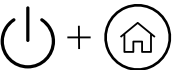

Image	Description
	<p>Power Turns the appliance on or off.</p> <hr/> <p>Connecting to LG ThinQ Press and hold the Power button for 3 seconds to prepare the status for connecting appliance and wi-fi.</p>
	<p>Mode Selects the desired operating mode.</p> <ul style="list-style-type: none"> Each press changes the mode in this order: Cooling → Auto → Dehumidification → Heating → Fan <hr/> <p>Connecting the Appliance and Remote Control</p> <ul style="list-style-type: none"> Press and hold the Mode button for about 3 seconds to connect the appliance and remote control.
	<p>Sleep Automatically turns the appliance off at a desired time. Use it before sleeping.</p>
	<p>Display Turns the appliance's screen on, off, or changes it.</p> <ul style="list-style-type: none"> Each time you press the  button, the appliance screen changes in the order of cover screen ↔ home screen. <hr/> <p>Turning the Appliance's Screen On or Off Press and hold the  button for 3 seconds to turn the appliance's screen on or off</p>
	<p>Energy/Jet Selects the desired function.</p> <ul style="list-style-type: none"> In the Cooling mode, each time you press the Energy/Jet button the mode changes in the following order: Energy Saving → Smart Care → Jet Cooling → Cooling. In the Heating mode, each time you press the Energy/Jet button the mode changes in the following order: Smart care → Jet Heating → Heating. <hr/> <p>Turning Indirect Airflow On or Off Press and hold the Energy/Jet button for 3 seconds to turn Indirect Airflow on or off</p>
	<p>Temperature  </p> <p>Adjusts the desired room temperature.</p>

Image	Description
	<p>Fan Speed +, - Adjusts the fan speed</p> <ul style="list-style-type: none"> The fan speed can be set in order of 1 ↔ 2 ↔ 3 ↔ 4 ↔ 5 ↔ Auto levels.
	<p>Pointer Checks or sets various functions on the appliance screen using the remote control.</p>
	<p>Sound Volume - Reduces or turns off the notification sounds that occur when you set up or change appliance features.</p>
	<p>Sound Volume + Turns on or increases the notification sounds that occur when you set up or change appliance features.</p>
	<p>Function Sets Plasmaster Ionizer, Auto Clean+, Freeze Cleaning, Sleep Timer, On Timer, Off Timer, Cancel all Timer, Smart Diagnosis, and LED Light.</p>
	<p>Reset Resets the wireless remote control setting. Open the remote control battery cover and then press the Reset button to reset it.</p>
	<p>If the appliance system operates slowly or freezes while using the appliance, or if the appliance suddenly turns off, you can restart the product.</p> <ul style="list-style-type: none"> Press and hold the  button and the  button on the remote control at the same time for 3 seconds.

Setting Functions

Image	Description
<p>Plasmaster Ionizer</p>	<p>Ion particles from Ionizer reduce the surface bacteria and other harmful substances.</p>
<p>Auto Clean+</p>	<p>Moisture remaining in the heat exchanger can be reduced by operating the appliance in a blowing state for a certain period of time.</p>
<p>Freeze Cleaning</p>	<p>Contaminants such as dust are reduced by repeating the process of freezing and thawing the heat exchanger inside the appliance.</p>
<p>Sleep Timer</p>	<p>Sets sleep mode to help you sleep better.</p> <ul style="list-style-type: none"> Sleep mode starts from 30 minutes and can be set in hourly increments up to 12 hours.

18 OPERATION

Image	Description
On Timer	Sets the appliance to turn on automatically at a desired time. <ul style="list-style-type: none">• For On Timer, you can set the desired time in 1-hour increments from 1 hour to 24 hours.
Off Timer	Sets the appliance to turn off automatically at a desired time. <ul style="list-style-type: none">• For Off Timer, you can set the desired time in 1-hour increments from 1 hour to 24 hours.
Cancel all Timer	Cancels all timer settings.
Smart Diagnosis	Easily check the maintenance information of an appliance.
LED Light	Turns on and off the LED light which is located on the lower right side of the appliance.

NOTE

- If the remote control is not connected, some functions cannot be used.
 - When you turn the remote control off and on again, the last used settings will appear on the remote control display.
 - The remote control display may differ from the image in the owner's manual depending on the model.
-

Using Wireless Remote Control

Cooling Mode

When the Cooling mode operates, cold air comes out from the air outlet.

- 1 Turn the appliance on.
- 2 Press the **Mode** button repeatedly to select the **Cooling** mode. The icon representing the **Cooling** mode appears and cooling operation begins.

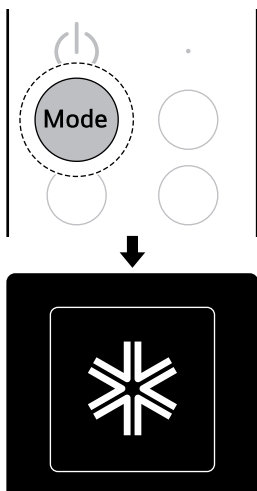

- You can check the operation mode on the indoor unit display.

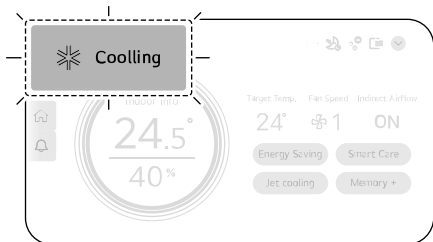

- 3 Press the **▲** or **▼** button to set the desired temperature.

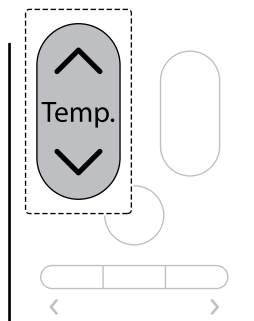

- You can check the desired temperature on the indoor unit display.

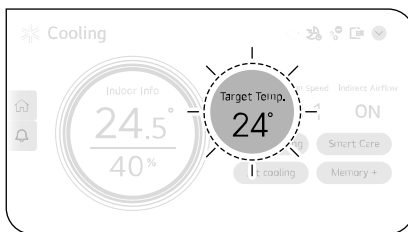

- 4 Press the **+** or **-** button to set the desired fan speed.

- The Fan Speed can be set to 1 ↔ 2 ↔ 3 ↔ 4 ↔ 5 ↔ **Auto** levels.

- When set to **Auto**, the fan speed is automatically adjusted.

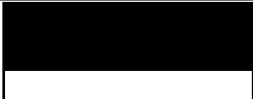
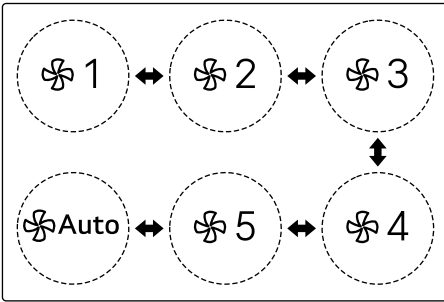
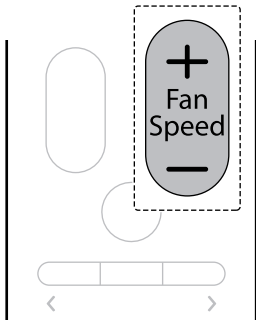

- You can check the fan speed on the indoor unit display.

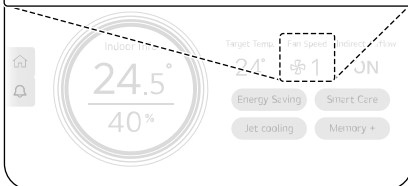
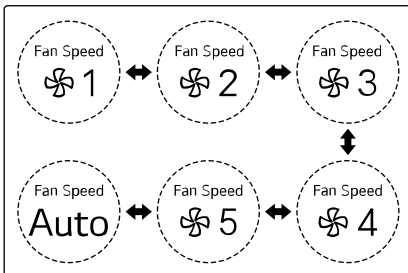

Using Additional Cooling Functions

You can set Energy Saving, Smart Care, Jet Cooling and Comfort Air.

Energy Saving

The desired temperature is automatically adjusted to save on power consumption.

- 1 Turn the appliance on.
- 2 Press the **Mode** button repeatedly to select the **Cooling** mode.

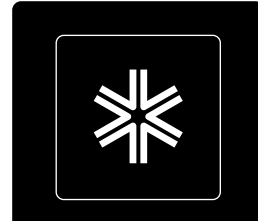
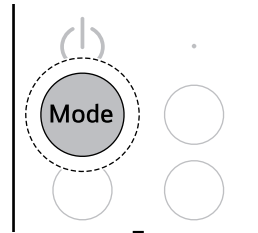

- 3 When cooling operation begins, press the **Energy/Jet** button repeatedly to select the **Energy Saving** mode. The icon representing the **Energy Saving** mode appears and cooling operation in **Energy Saving** mode begins.
 - Each time you press the **Energy/Jet** button, the mode changes in the order of **Energy**

Saving → Smart Care → Jet Cooling → Cooling.

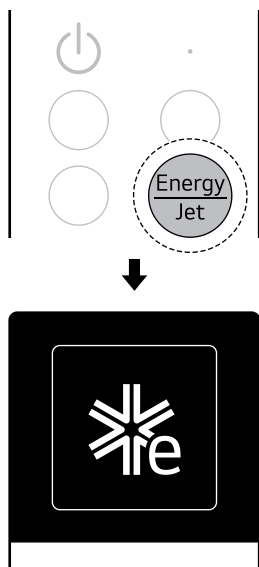

- You can set the Energy Saving mode or check the setting status on the indoor unit display.

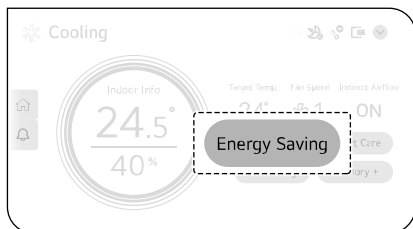

Smart Care

The appliance operates most efficiently by analyzing the surrounding environment and user characteristics. After reaching the desired temperature, the fan speed is automatically adjusted, allowing you to live comfortably.

- Turn the appliance on.
- Press the **Mode** button repeatedly to select the **Cooling** mode.

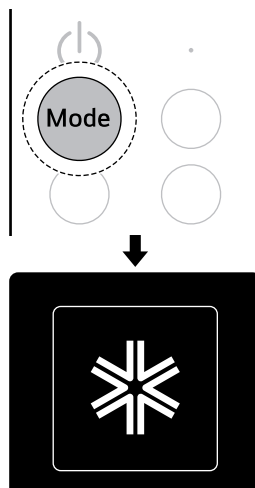

- When cooling operation begins, press the **Energy/Jet** button repeatedly to select the **Smart Care** mode. The icon representing the **Smart Care** mode appears and cooling operation in **Smart Care** mode begins.
 - Each time you press the **Energy/Jet** button, the mode changes in the order of **Energy**

NOTE

- The temperature automatically settles at 22°C if desired temperature is below 22°C. The temperature remains constant if it is above 22°C.
- After a certain period of time has elapsed since the start of Energy Saving function, the temperature or fan speed is automatically set according to the surrounding environment, so the temperature or fan speed displayed on the indoor unit display or remote control display may differ from the actual one.

Saving → Smart Care → Jet Cooling → Cooling.

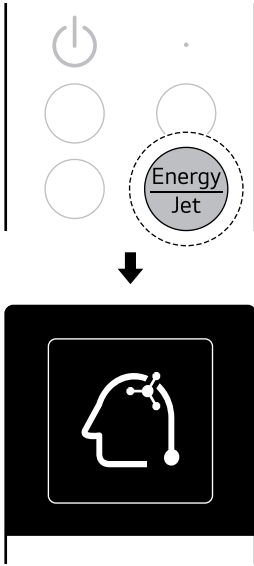

- You can set the Smart Care mode or check the setting status on the indoor unit display.

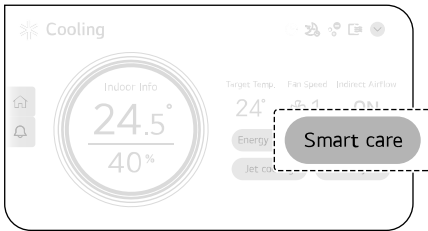

NOTE

- Because the temperature is adjusted to suit the user and usage environment, the desired temperature displayed on the indoor unit display may be different.
- If the appliance is relocated or the user changes, reset the previously entered information. → See **Using the Power Button (Resetting Learned Information)**.

Jet Cooling

It blows out colder air than a regular air conditioner and cools you down quickly.

- Turn the appliance on.
- Press the **Mode** button repeatedly to select the **Cooling** mode.

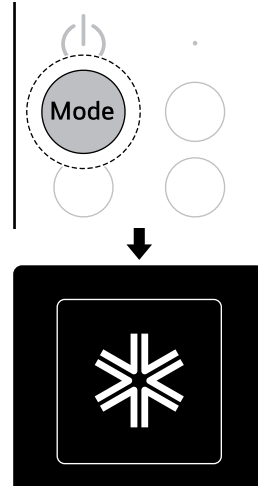

- When cooling operation begins, press the **Energy/Jet** button repeatedly to select the **Jet Cooling** mode. The icon representing the **Jet Cooling** mode appears and cooling operation in **Jet Cooling** mode begins.

- Each time you press the **Energy/Jet** button, the mode changes in the order of **Energy**

Saving → Smart Care → Jet Cooling → Cooling.

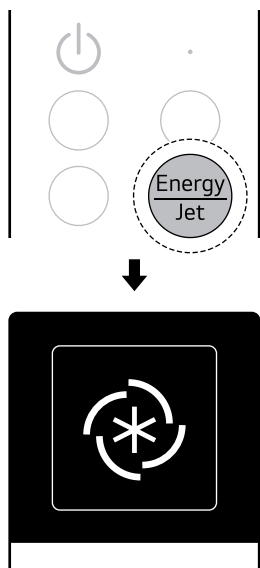

- You can set the Jet Cooling mode or check the setting status on the indoor unit display.

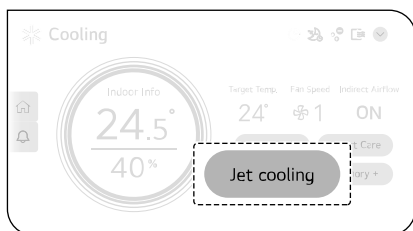

2 Press the **Mode** button repeatedly to select the **Cooling** mode.

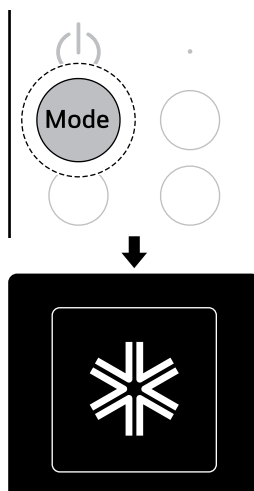

- 3 When cooling operation begins, press and hold the **Energy/Jet** button for 3 seconds. **Indirect On** appears and no air comes out of the air outlet at the bottom of the appliance.
- Each time you press and hold the **Energy/Jet** button for 3 seconds, the indirect airflow

NOTE

- When cooling operation on the Jet Cooling mode begins, the fan speed changes to high fan speed and the desired temperature is automatically set.

Comfort Air

You can adjust in the way that no air comes out of the air outlet at the bottom of the appliance so that it is not directly hit by air.

- 1 Turn the appliance on.

changes in the order of **Indirect On** ↔ **Indirect Off**.

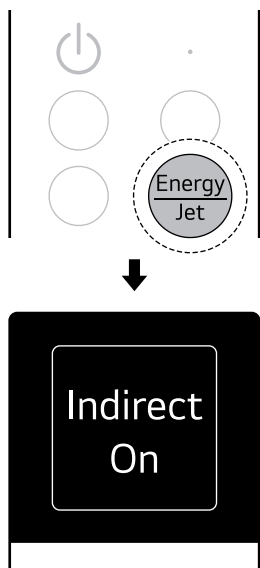

- You can check the Comfort Air setting status on the indoor unit display.

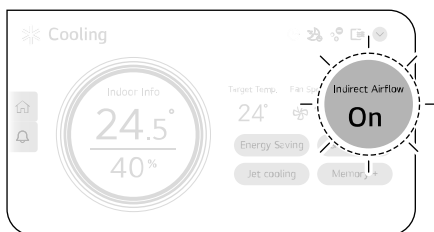

Auto Mode

The appliance will automatically set the operation mode to **Cooling** or **Heating** depending on the room temperature. You can set the desired temperature and fan speed.

- Turn the appliance on.

- Press the **Mode** button repeatedly to select the **Auto** mode. The icon representing the **Auto** mode appears and **Auto** mode begins.

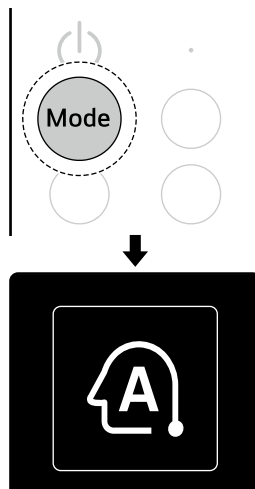

- You can check the operation mode on the indoor unit display.

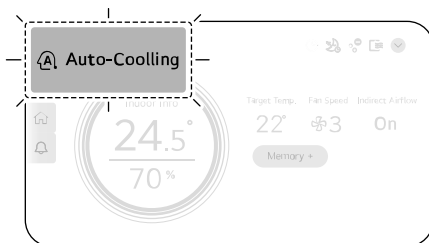

- Press the **▲** or **▼** button to set the desired temperature.

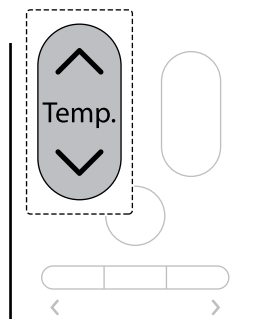

- You can check the desired temperature on the indoor unit display.

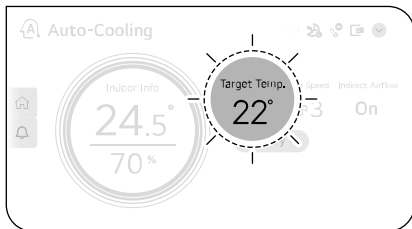

4 Press the **+** or **-** button to set the desired fan speed.

- The fan speed can be set to 1 ↔ 2 ↔ 3 ↔ 4 ↔ 5 ↔ **Auto** levels.
- When set to **Auto**, the fan speed is automatically adjusted.

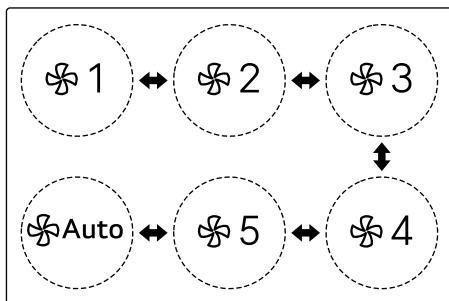
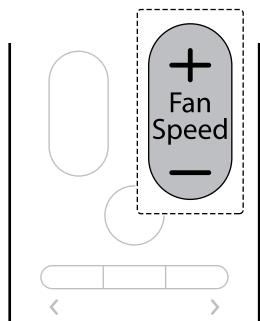

- You can check the fan speed on the indoor unit display.

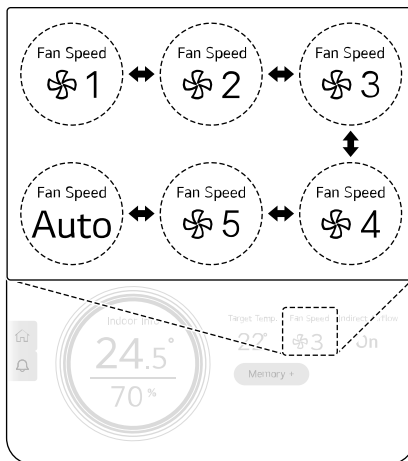

Using Additional Auto Functions

You can set Comfort Air.

Comfort Air

You can adjust in the way that no air comes out of the air outlet at the bottom of the appliance so that it is not directly hit by air.

- 1 Turn the appliance on.

- 2** Press the **Mode** button repeatedly to select the **Auto** mode.

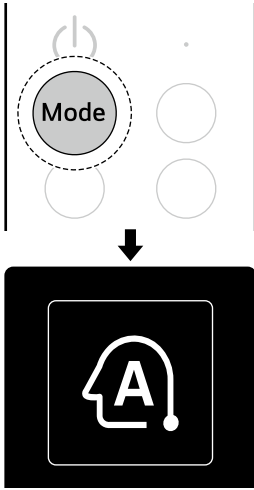

changes in the order of **Indirect On** ↔ **Indirect Off**.

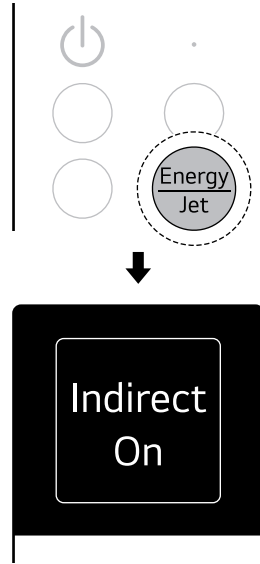

- 3** When Auto mode begins, press and hold the **Energy/Jet** button for 3 seconds. **Indirect On** appears and no air comes out of the air outlet at the bottom of the appliance.

- Each time you press and hold the **Energy/Jet** button for 3 seconds, the indirect airflow

- You can check the Comfort Air setting status on the indoor unit display.

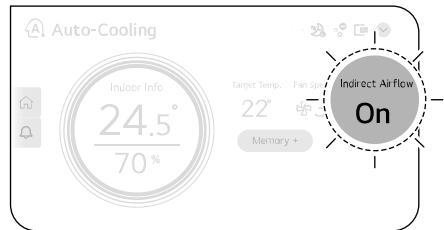

Dehumidification Mode

It reduces indoor moisture on days with high humidity, allowing you to live comfortably.

- 1** Turn the appliance on.
- 2** Press the **Mode** button repeatedly to select the **Dehumidification** mode. The icon

representing the **Dehumidification** mode appears and **Dehumidification** mode begins.

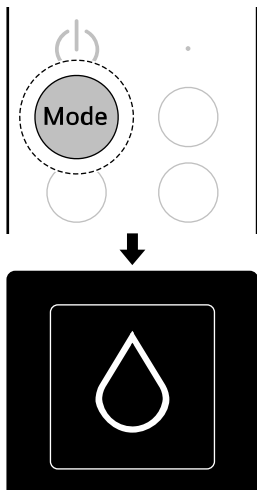

- You can check the operation mode on the indoor unit display.

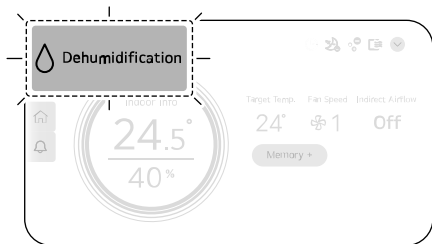

- Press the **▲** or **▼** button to set the desired temperature.

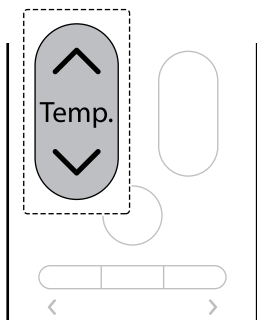

- You can check the desired temperature on the indoor unit display.

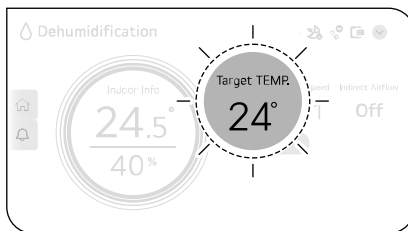

NOTE

- When a certain period of time has passed after starting operation in the Dehumidification mode, the fan speed is automatically set according to the surrounding environment.
- When connected to the Multi Outdoor unit, you cannot adjust the temperature.

Using Additional Dehumidification Functions

You can set Comfort Air.

Comfort Air

You can adjust in the way that no air comes out of the air outlet at the bottom of the appliance so that it is not directly hit by air.

- Turn the appliance on.

- 2** Press the **Mode** button repeatedly to select the **Dehumidification** mode.

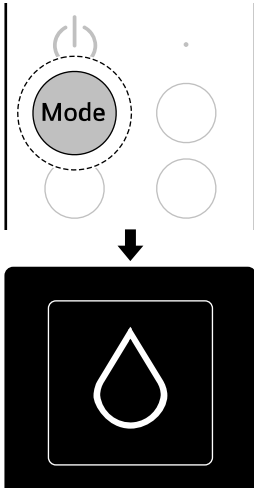

changes in the order of **Indirect On** ↔ **Indirect Off**.

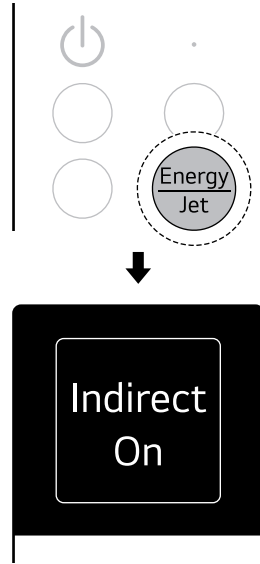

- 3** When Dehumidification mode begins, press and hold the **Energy/Jet** button for 3 seconds. **Indirect On** appears and no air comes out of the air outlet at the bottom of the appliance.

- Each time you press and hold the **Energy/Jet** button for 3 seconds, the indirect airflow

- You can check the Comfort Air setting status on the indoor unit display.

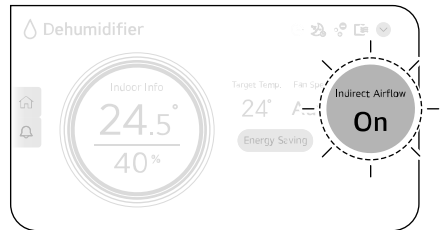

Heating Mode

When the heating mode operates, warm air comes out from the air outlet.

- 1** Turn the appliance on.
- 2** Press the **Mode** button repeatedly to select the **Heating** mode. The icon representing the

Heating mode appears and heating operation begins.

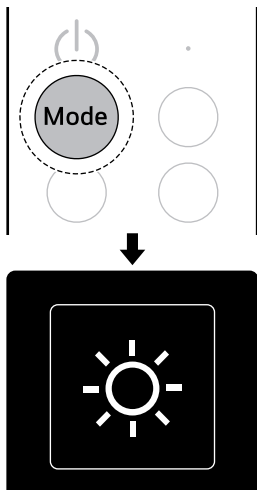

- You can check the desired temperature on the indoor unit display.

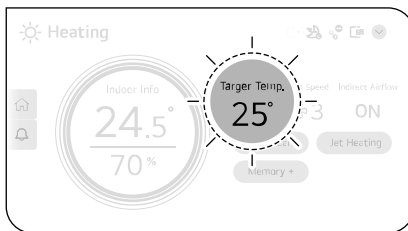

- You can check the operation mode on the indoor unit display.

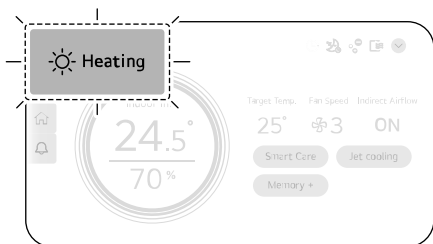

4 Press the **+** or **-** button to set the desired fan speed.

- The fan speed can be set to 1 ↔ 2 ↔ 3 ↔ 4 ↔ 5 ↔ **Auto** levels.
- When set to **Auto**, the fan speed is automatically adjusted.

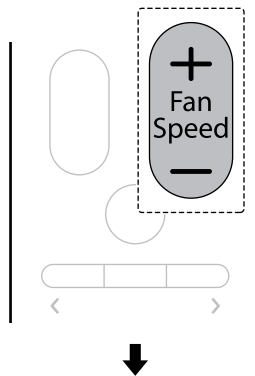

3 Press the **▲** or **▼** button to set the desired temperature.

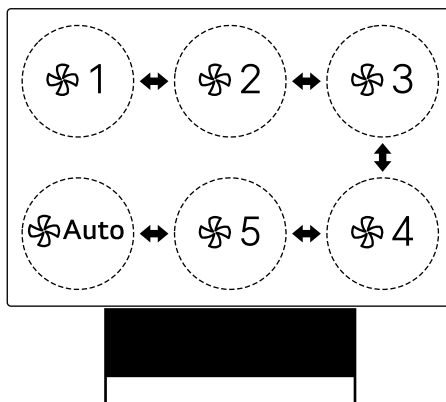
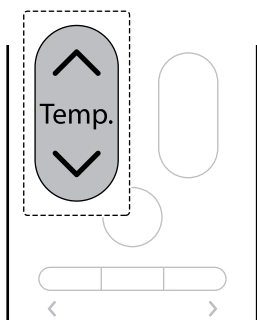

30 OPERATION

- You can check the fan speed on the indoor unit display.

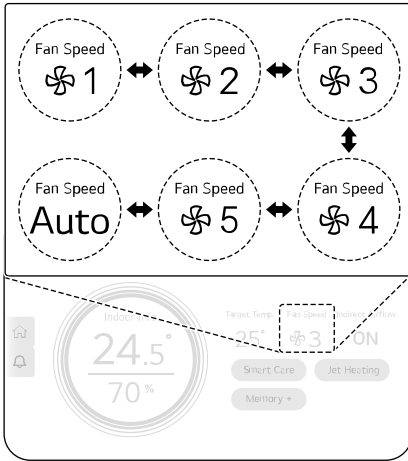

NOTE

- When preheating and defrosting of the outdoor unit in heating operation, no air comes out.

Using Additional Heating Functions

You can set Smart Care, Jet Heating and Comfort Air.

Smart Care

The appliance operates most efficiently by analyzing the surrounding environment and user characteristics. After reaching the desired temperature, the fan speed is automatically adjusted, allowing you to live comfortably.

- 1 Turn the appliance on.

- 2 Press the **Mode** button repeatedly to select the **Heating** mode.

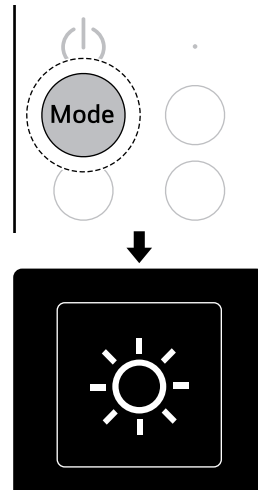

- 3 When heating operation begins, press the **Energy/Jet** button repeatedly to select the **Smart Care** mode. The icon representing the **Smart Care** mode appears and heating operation in **Smart Care** mode begins.

- Each time you press the **Energy/Jet** button, the mode changes in the order of **Smart Care** → **Jet Heating** → **Heating**.

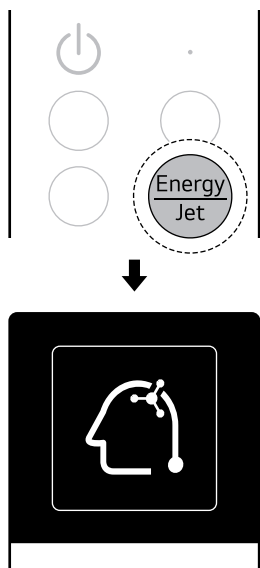

- You can set the Smart Care mode or check the setting status on the indoor unit display.

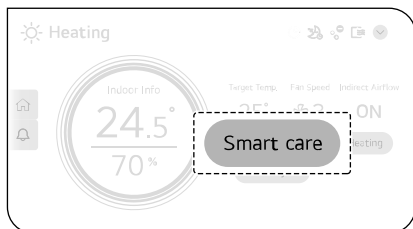

Jet Heating

It can warm the room faster than regular hot air.

- Turn the appliance on.
- Press the **Mode** button repeatedly to select the **Heating** mode.

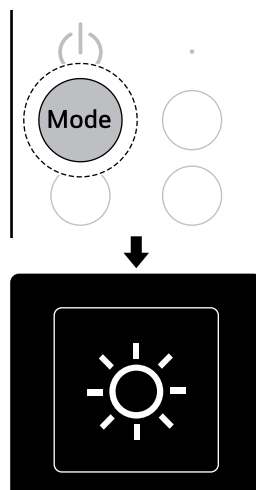

- When heating operation begins, press the **Energy/Jet** button repeatedly to select the **Jet Heating** mode. The icon representing the **Jet Heating** mode appears and heating operation in **Jet Heating** mode begins.

NOTE

- Because the temperature is adjusted to suit the user and usage environment, the desired temperature displayed on the indoor unit display may be different.
- If the appliance is relocated or the user changes, reset the previously entered information. → See **Using the Power Button (Resetting Learned Information)**.

32 OPERATION

- Each time you press the **Energy/Jet** button, the mode changes in the order of **Smart Care** → **Jet Heating** → **Heating**.

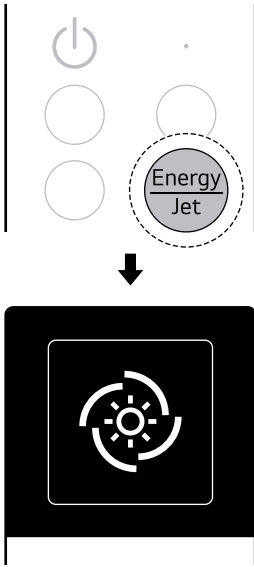

- You can set the Jet Heating mode or check the setting status on the indoor unit display.

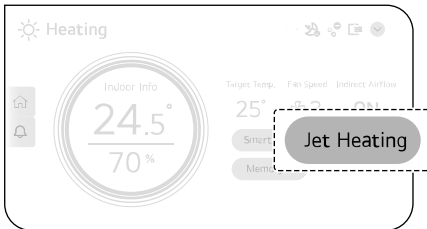

- 1 Turn the appliance on.
- 2 Press the **Mode** button repeatedly to select the **Heating** mode.

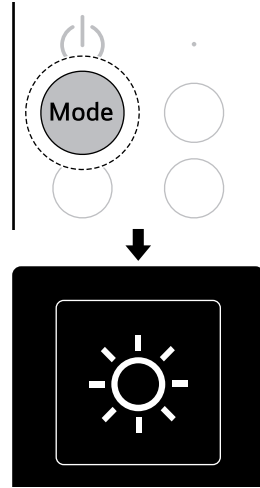

- 3 When heating operation begins, press and hold the **Energy/Jet** button for 3 seconds. **Indirect On** appears and no air comes out of the air outlet at the bottom of the appliance.
 - Each time you press and hold the **Energy/Jet** button for 3 seconds, the indirect airflow

NOTE

- When the operation in the Jet Heating mode begins, the fan speed changes to high fan speed and the desired temperature is automatically set.

Comfort Air

You can adjust in the way that no air comes out of the air outlet at the bottom of the appliance so that it is not directly hit by air.

changes in the order of **Indirect On** ↔ **Indirect Off**.

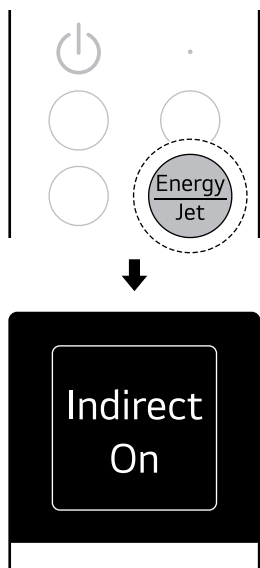

- You can check the Comfort Air setting status on the indoor unit display.

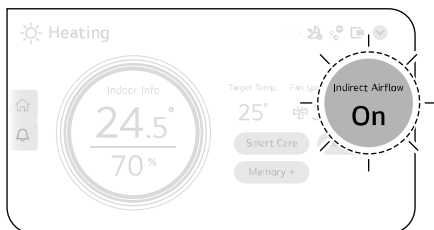

Fan Mode

You can circulate the indoor air without changing the room temperature.

- Turn the appliance on.

- Press the **Mode** button repeatedly to select the **Fan** mode. The icon representing the **Fan** mode appears and **Fan** mode begins.

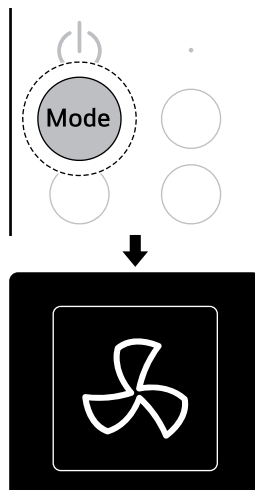

- You can check the operation mode on the indoor unit display.

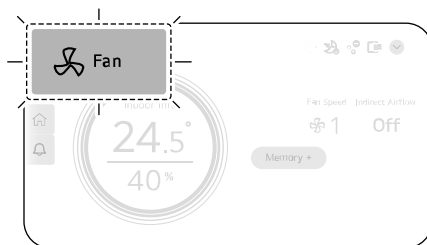

- Press the **+** or **-** button to set the desired fan speed.

- The fan speed can be set to 1 ↔ 2 ↔ 3 ↔ 4 ↔ 5 ↔ **Auto** levels.

- When set to **Auto**, the fan speed is automatically adjusted.

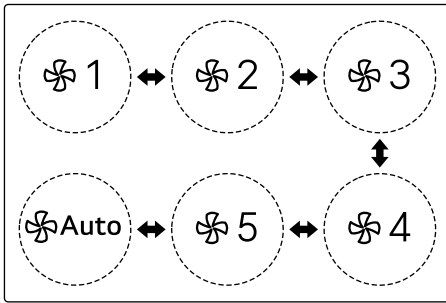
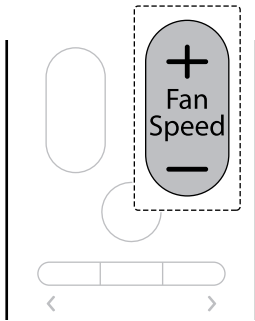

- You can check the fan speed on the indoor unit display.

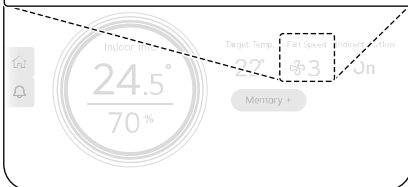
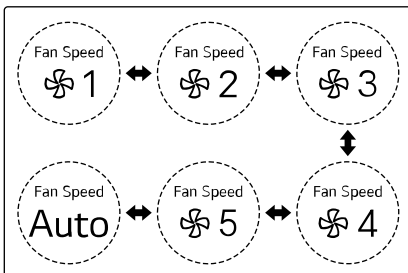

NOTE

- Temperature control cannot be performed during Fan mode.

Using Additional Fan Functions

You can set Comfort Air.

Comfort Air

You can adjust in the way that no air comes out of the air outlet at the bottom of the appliance so that it is not directly hit by air.

- 1 Turn the appliance on.
- 2 Press the **Mode** button repeatedly to select the **Fan** mode.

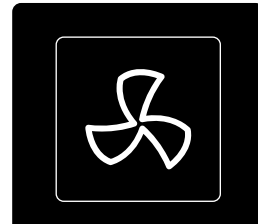
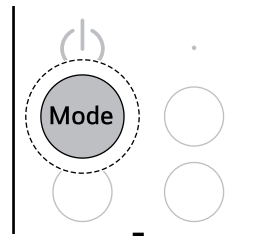

- 3 When Fan mode begins, press and hold the **Energy/Jet** button for 3 seconds. **Indirect On** appears and no air comes out of the air outlet at the bottom of the appliance.

- Each time you press and hold the **Energy/Jet** button for 3 seconds, the indirect airflow

changes in the order of **Indirect On** ↔ **Indirect Off**.

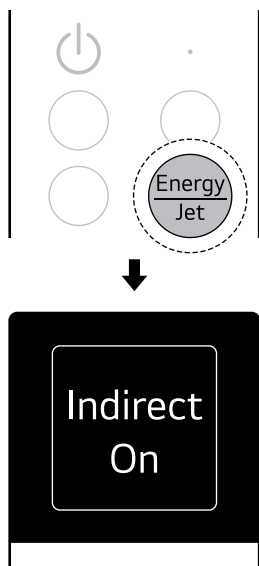

- You can check the Comfort Air setting status on the indoor unit display.

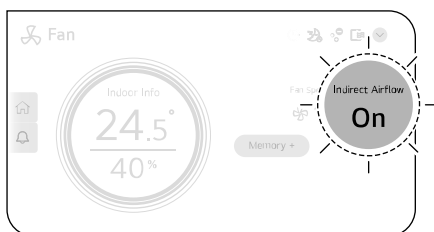

Using Ionizer function with the desired operating mode

- Turn the appliance on.
- Press the **Mode** button repeatedly to select the desired operating mode.

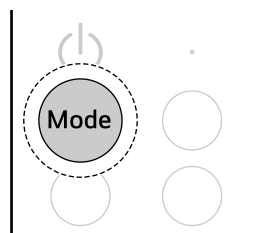

- Press the **Function** button.

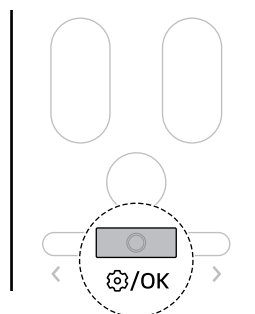

Additional Features and Settings

Ionizer Function

These functions supply clean and fresh air by ion particles and the filter. Ion particles from Ionizer reduce the surface bacteria and other harmful substances.

- 4** Press the **<** or **>** button to select the **Plasmaster Ionizer** mode and then press the **Function** button.

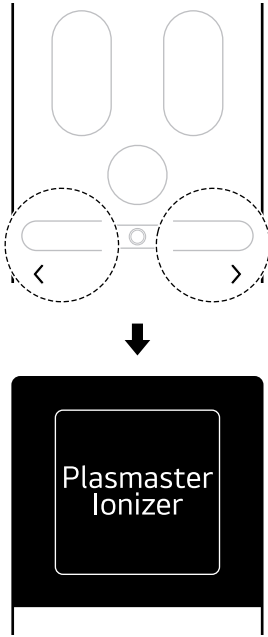

- Each time you press the **<** or **>** button, it changes in the order of **On** ↔ **Off** ↔ **Back**.

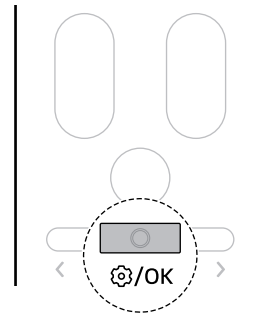
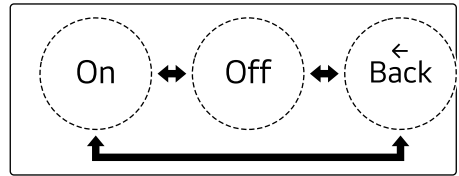

- 5** Press the **<** or **>** button to select the desired settings and then press the **Function** button. Setup is complete.

- You can check the Ionizer function setting status on the indoor unit display.

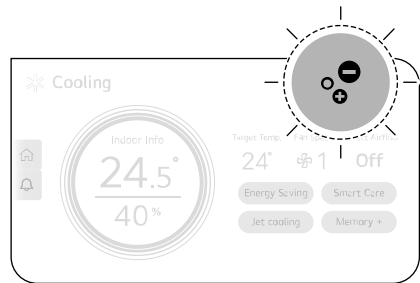

Using Ionizer function independently

- 1** Turn the appliance off.

- 2 Press the **Function** button.

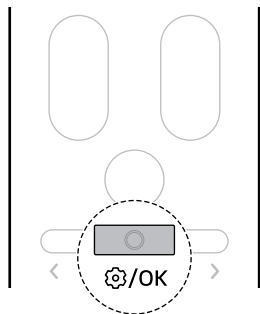

- Each time you press the < or > button, it changes in the order of **On** ↔ **Off** ↔ **Back**.

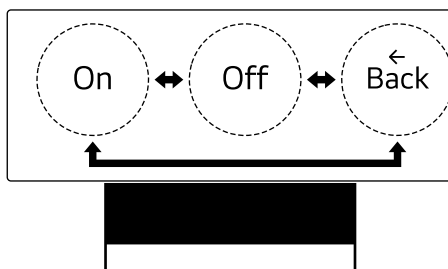

- 3 Press the < or > button to select the **Plasmaster Ionizer** mode and then press the **Function** button.

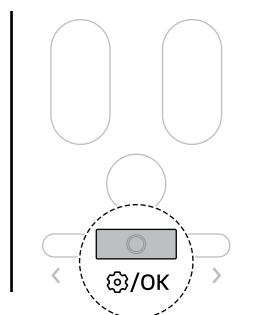
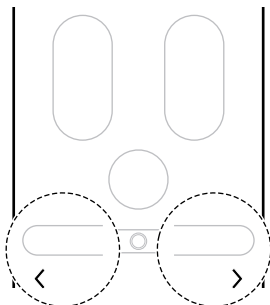

- You can check the Ionizer function setting status  on the remote control display.



- 4 Press the < or > button to select the desired settings and then press the **Function** button. Setup is complete.

Sleep Timer Function

The appliance operates to help you sleep comfortably according to your sleep stage.

Using the Sleep Timer

- 1 Turn the appliance on.
- 2 Press the **Sleep** button. To complete the reservation, press the **Sleep** button repeatedly to select the desired time. Your reservation is complete.
 - Starting from 30 minutes, the Sleep Timer can be set in hourly increments up to 12

hours. The mode will be automatically canceled after operation for the set time.

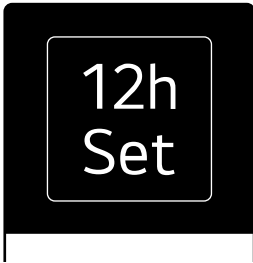
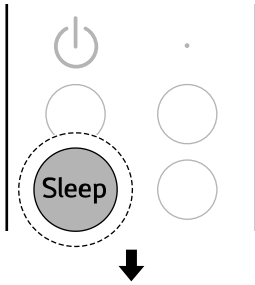

- You can check the sleep function setting status on the indoor unit display.

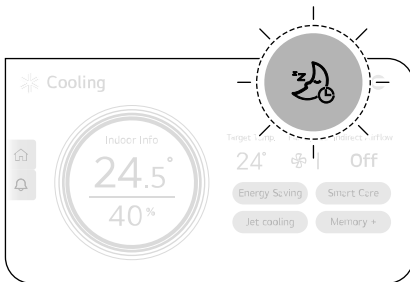

2 Press the **Function** button.

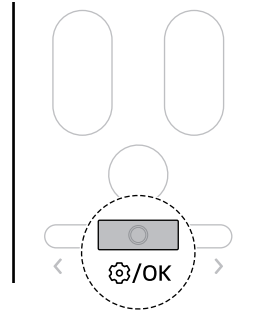

3 Press the **<** or **>** button to select the **Sleep Timer** and then press the **Function** button.

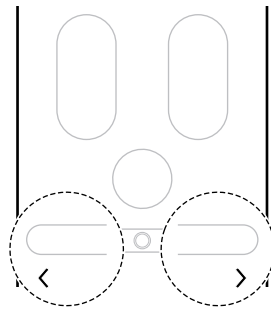

Using the Sleep Timer in Function

1 Turn the appliance on.

- 4 Press the < or > button to select the desired time and then press the **Function** button. Your reservation is complete.

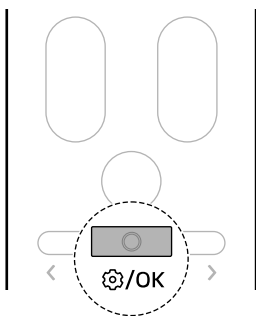

- 1 Press the **Function** button.

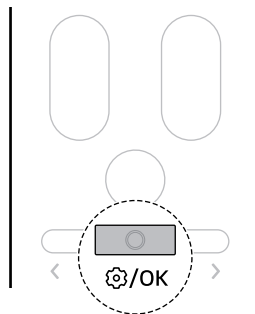

- 2 Press the < or > button to select the **On Timer** and then press the **Function** button.

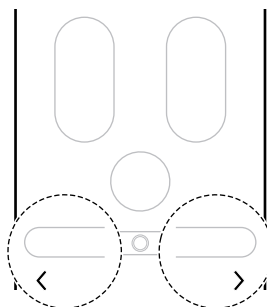

NOTE

- When Sleep Timer is set and you select the **Sleep Timer**, you can check the remaining time, cancel the reservation, or reset the reservation time.
- The fan speed is set to the weakest.
- If you turn off the appliance during operation, Sleep Timer will be disabled.
- Sleep Timer cannot be set when the appliance is not operating.
- Even if the LED light is on, if you set the Sleep Timer, the LED light will automatically turn off.

On and Off Timer

Using the On Timer

The appliance automatically turns on at the time you set.

- 3 Press the < or > button to select the desired time and then press the **Function** button. Your reservation is complete.

40 OPERATION

- You can set the desired time in 1-hour increments from 1 hour to 24 hours.

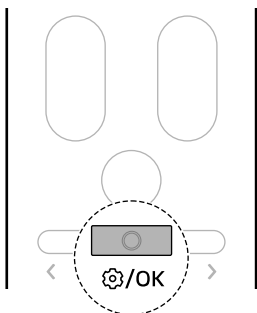
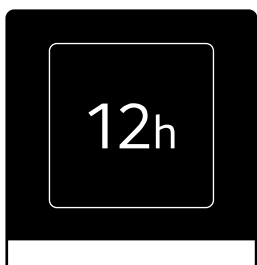

- 1 Press the **Function** button.

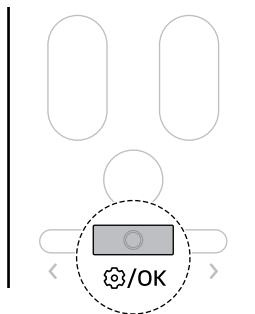

- 2 Press the < or > button to select the **Off Timer** and then press the **Function** button.

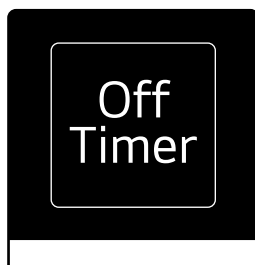
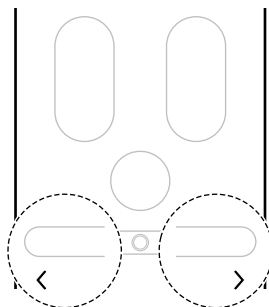

NOTE

- When On Timer is set and you select the **On Timer**, you can check the remaining time, cancel the reservation, or reset the reservation time.

Using the Off Timer

The appliance automatically turns off at the set time.

- 3 Press the < or > button to select the desired time and then press the **Function** button. Your reservation is complete.

- You can set the desired time in 1-hour increments from 1 hour to 24 hours.

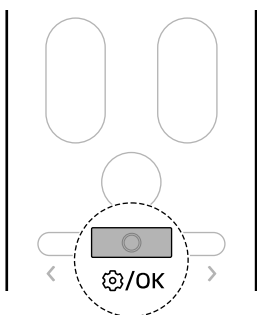
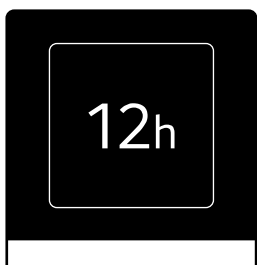

- Press the **Function** button.

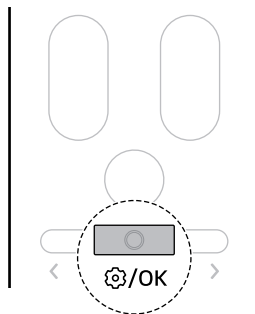

- Press the < or > button to select the **Cancel all Timer** and then press the **Function** button.

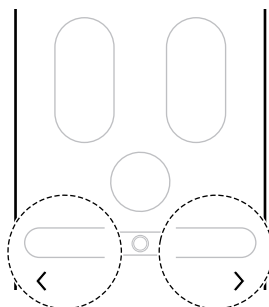

NOTE

- When Off Timer is set and you select the **Off Timer**, you can check the remaining time, cancel the reservation, or reset the reservation time.
- You can set the On Timer and the Off Timer together.
- You can set the On Timer and the Off Timer even when the appliance is not operating.

Cancel all Timer

You can cancel all timer settings.

42 OPERATION

- 3 Press the < or > button to select **Cancel** and then press the **Function** button. All timer settings will be cancelled.

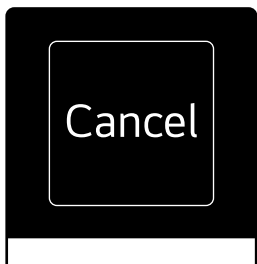

- 3 Press the < or > button to select **Smart Diagnosis** and then press the **Function** button.

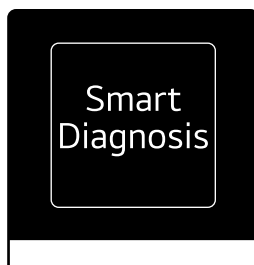
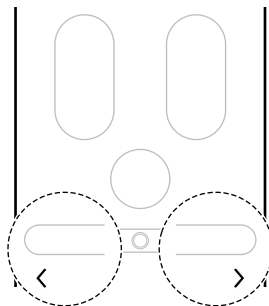

Smart Diagnosis

Use this feature to help you diagnose and solve problems

- 1 Turn the appliance on.
- 2 Press the **Function** button.

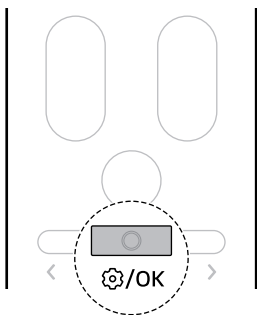

- 4 Press the < or > button to select **Start** and then press the **Function** button to start smart diagnosis.

- Each time you press the < or > button, it changes in the order of **Start** ↔ **Back**.

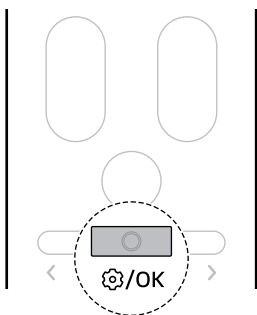
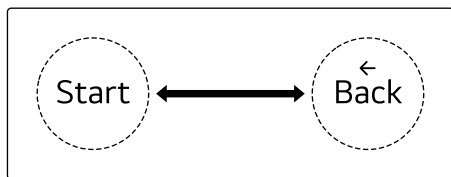

- 1 Press the **Function** button.

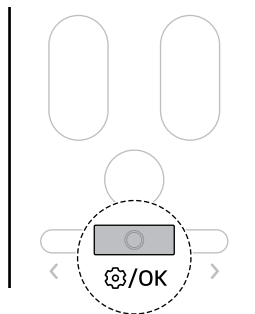

- 2 Press the < or > button to select **LED Light** and then press the **Function** button.

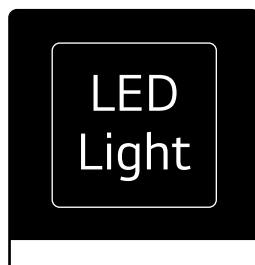
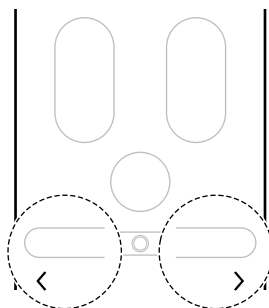

NOTE

- You can set up the smart diagnosis function even when the appliance is not operating.
- You can use the smart diagnosis function when diagnosing the appliance with a beep sound. → See **SMART FUNCTIONS(Using Audible Diagnosis to Diagnose Issues)**.

Setting LED Light

You can turn the LED light on the remote control receiver on and off.

- 3 Press the < or > button to select **On** and then press the **Function** button. The LED light turns on.

- Each time you press the < or > button, it changes in the order of **On** ↔ **Off** ↔ **Back**.

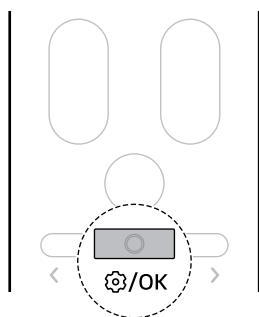
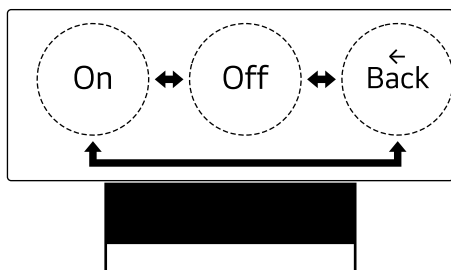

Adjusting the Sound Volume

You can adjust the volume of the notification sound that informs you of the status when setting or changing appliance functions.

- Press the **Sound Volume +** - button on the remote control.

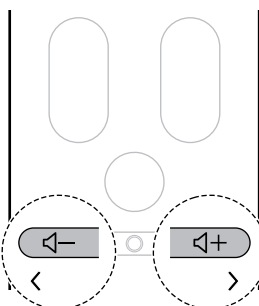

- You can check the sound volume on the indoor unit display, and press the button on the

indoor unit display with the remote control pointer.

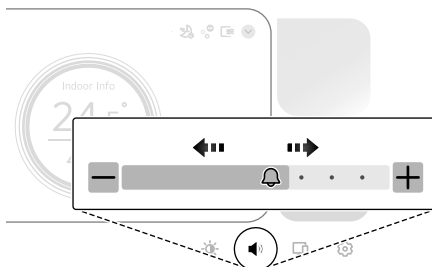

NOTE

- You can adjust the sound volume whether the appliance is turned on or off.

Setting the Display Brightness

You can adjust the display brightness of the indoor unit.

- You can set the display brightness by pressing the button on the indoor unit display with the remote control pointer.

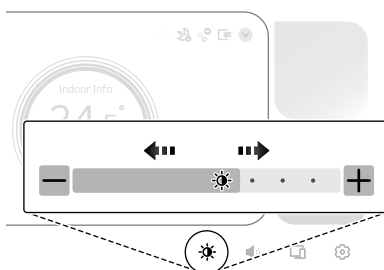

NOTE

- You can set the display brightness even when the appliance is not operating.
- Even if you adjust the display brightness to dark, the display does not turn off. The display brightness can be turned off by pressing and holding the button for 3 seconds.

Display Overview

Indoor Unit Display

You can check the desired temperature and operation status of additional functions on the display of the indoor unit.

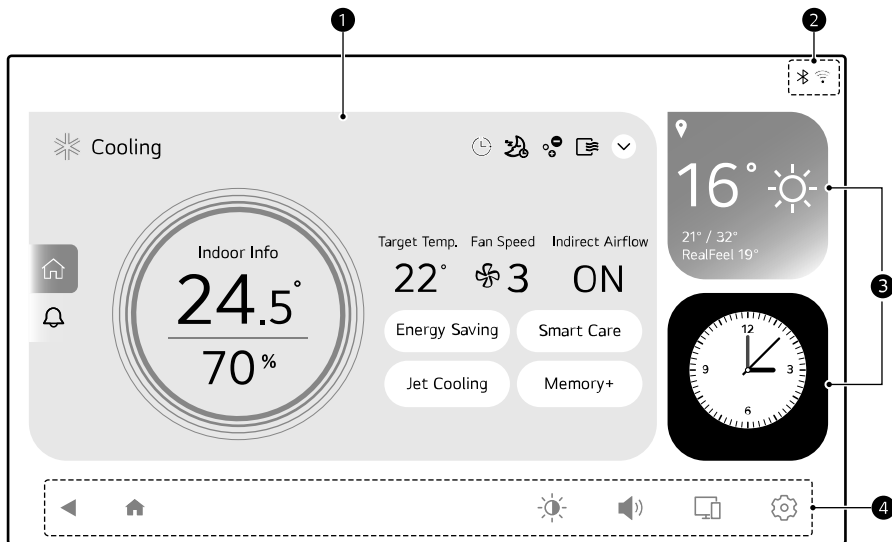

1 Air Conditioner-Specific Widget

You can check the appliance's operating status, setting status, and indoor information, and set additional functions according to the appliance operation mode.

• Operating Mode

- You can check the operating mode currently in operation.

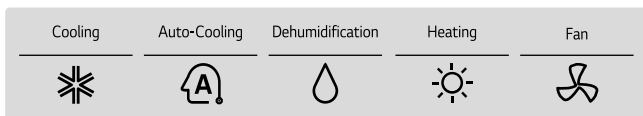



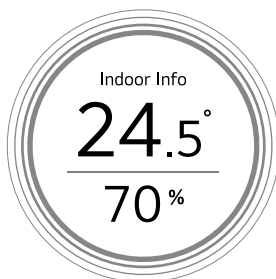

• Indoor Information

- You can check the current indoor temperature and humidity.



- **Additional Function Status Widget**

- You can check the status of the add-ons you have set.

On and Off Timer	Sleep Timer	Ionizer	Auto Clean+
			
Target Temp.	Fan Speed	Indirect Airflow	
24°	 2	Off	

- **Additional Function Control Widget**

- Additional functions can be used depending on the operating mode.

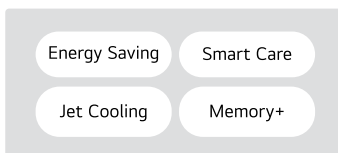

TIP

- Save frequently used operation settings using the memory function. Select Memory+ on the additional function control widget with the remote control pointer and press the Save button to save the current operation settings.

- It can be saved during operation in modes such as Cooling, Auto, Dehumidification, Heating, Fan, Energy Saving, Jet Cooling, and Smart Care.

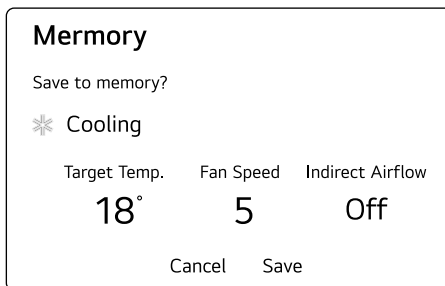

- Once the operation settings are saved, you can select the memory on the additional function control widget with the remote control pointer to check, execute, or delete the saved operation settings.

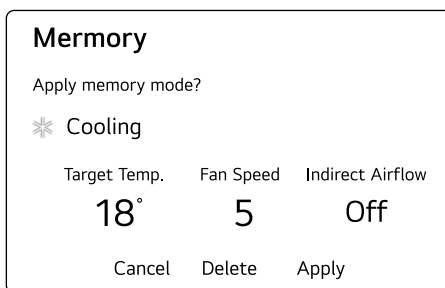

• Notification Screen

- You can check energy monitoring, maintenance monitoring, and new notifications.

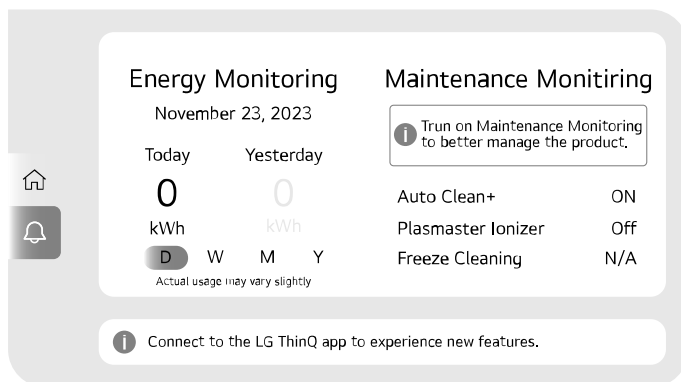

② Connection Status Widget



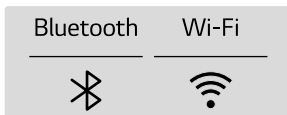



You can check Wi-Fi and Bluetooth status.



3 Weather/Clock Widget

You can check the current time and the weather in the area set by the user. Select the widget to check detailed information or set it.

4 Button

Button	Description
 Previous Screen	You can return to the screen from the previous step.
 Home Screen	You can return to the home screen.
 Screen Brightness	You can adjust the screen brightness of the indoor unit display.
 Sound Volume	You can adjust the notification sound that notifies you when setting up or changing appliance features.
 Screen Mirroring	You can view the screen of your smart device or laptop equally on the appliance screen. <ul style="list-style-type: none"> • iOS-based devices or smart devices that do not support the screen sharing function cannot use this function. • The screen mirroring function may be restricted for copyright-protected paid content. • Depending on the model of your smart device, the name of the function may be different.
 Settings	You can set or check various features such as cover screen and style.

NOTE

- Functions cannot be selected by touching the indoor unit's display. You must use the remote control.

Using the Power Button

Manual Operation

If your wireless remote control is unavailable, you can turn the appliance on and off by pressing the **Power** button on the indoor unit.

- Open the front panel and press the **Power** button.

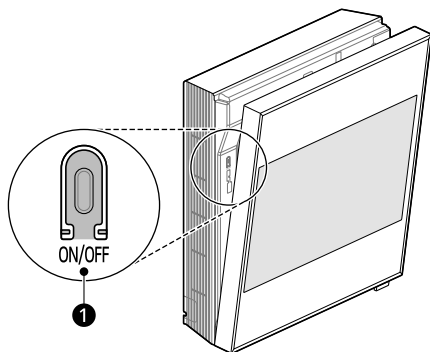

- 1 Power button

Restoring the Previous Settings

When the air conditioner is turned on again after a power failure, **Auto Restart** function restores the previous settings.

When using the appliance for the first time, **Auto Restart** function is set. You can cancel and set this function by pressing the **Power** button on the indoor unit.

Cancelling Auto Restart

- 1 Press and hold the **Power** button for about 6 seconds.

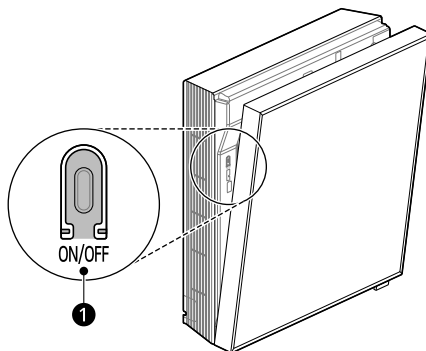

- 1 Power button

- 2 When the appliance beeps twice, release the **Power** button. The lamp will flash twice. This repeats 4 times.

Setting Auto Restart

- 1 Press and hold the **Power** button for about 6 seconds.

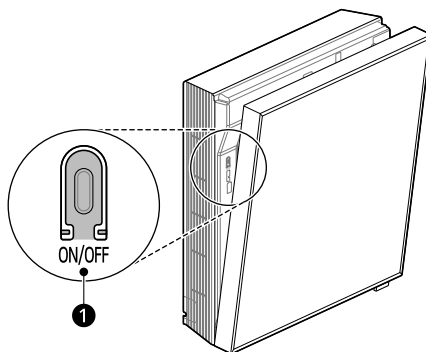

- 1 Power button

- 2 When the appliance beeps twice, release the **Power** button. The lamp will flash. This repeats 4 times.

Resetting Learned Information

You can reset the information gathered from the existing environments to allow learning of new spaces and user-specific information.

- 1 Open the front panel.
- 2 Press and hold the **Power** button for more than 13 seconds.
- 3 When the appliance beeps 4 times, release the **Power** button. The previously entered living area information will be deleted.

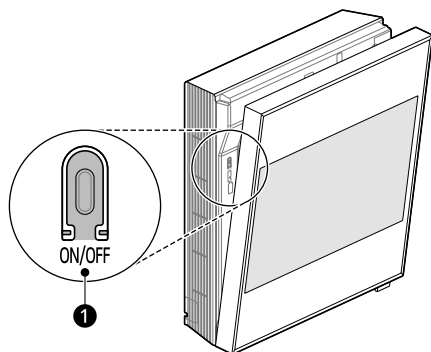

- 1 Power button

NOTE

- Be sure to release the button when you hear the beep four times. If you release the button before you hear the beep four times, other set functions may be disabled.
-

SMART FUNCTIONS

LG ThinQ Application

This feature is only available on models with Wi-Fi. The **LG ThinQ** application allows you to communicate with the appliance using a smartphone.

LG ThinQ Application Features

Common features

Communicate with the appliance from a smartphone using the **LG ThinQ** application.

- **Smart Diagnosis**

- If you experience a problem while using the appliance, this smart diagnosis feature will help you diagnose the problem.

Additional features

More features are available if your appliance is connected to Wi-Fi.

- Settings
 - Allows you to set various options on the appliance and in the application.

NOTE

- If you change your wireless router, internet service provider, or password, delete the registered appliance from the **LG ThinQ** application and register it again.
- The application is subject to change for appliance improvement purposes without notice to users.
- Functions may vary by model.

Installing LG ThinQ Application and Connecting an LG Appliance

Models with QR Code

Scan the QR code attached to the product using the camera or a QR code reader application on your smartphone.

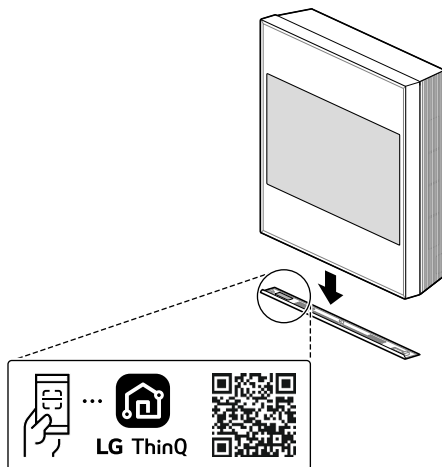

Models without QR Code

- 1 Search for and install the **LG ThinQ** application from the Google Play Store or Apple App Store on a smartphone.
- 2 Run the **LG ThinQ** application and sign in with your existing account or create an LG account to sign in.
- 3 Touch the add (+) button on the **LG ThinQ** application to connect your LG appliance. Follow the instructions in the application to complete the process.

NOTE

- To verify the Wi-Fi connection, check that the Wi-Fi indicator on the control panel is lit.
- The appliance supports 2.4 GHz Wi-Fi networks only. To check your network frequency, contact your Internet service provider or refer to your wireless router manual.
- **LG ThinQ** is not responsible for any network connection problems or any faults, malfunctions, or errors caused by network connection.
- The surrounding wireless environment can make the wireless network service run slowly.
- If the distance between the appliance and the wireless router is too far, the signal strength becomes weak. It may take a long time to connect or installation may fail.
- If the appliance is having trouble connecting to the Wi-Fi network, it may be too far from the router. Purchase a Wi-Fi repeater (range extender) to improve the Wi-Fi signal strength.
- The network connection may not work properly depending on the Internet service provider.
- The Wi-Fi connection may not connect or may be interrupted because of the home network environment.
- The appliance cannot be connected due to problems with the wireless signal transmission. Unplug the appliance and wait about a minute before trying again.
- If the firewall on your wireless router is enabled, disable the firewall or add an exception to it.
- The wireless network name (SSID) should be a combination of English letters and numbers. (Do not use special characters.)
- Smartphone user interface (UI) may vary depending on the mobile operating system (OS) and the manufacturer.
- If the security protocol of the router is set to **WEP**, you may fail to set up the network. Please change it to other security protocols (**WPA2** is recommended) and connect the appliance again.

Open Source Software Notice Information

To obtain the source code that is contained in this product, under GPL, LGPL, MPL, and other open source licenses that have the obligation to disclose source code, and to access all referred license terms, copyright notices and other relevant documents, please visit <https://opensource.lge.com>.

LG Electronics will also provide open source code to you on CD-ROM for a charge covering the cost of performing such distribution (such as the cost of media, shipping, and handling) upon email request to opensource@lge.com.

This offer is valid to anyone in receipt of this information for a period of three years after our last shipment of this product.

Diagnosis Using LG ThinQ

Use this feature to help you diagnose and solve problems with your appliance.

NOTE

- For reasons not attributable to LGE's negligence, the service may not operate due to external factors such as, but not limited to, Wi-Fi unavailability, Wi-Fi disconnection, local app store policy, or application unavailability.
- The feature may be subject to change without prior notice and may have a different form depending on where you are located.

Using LG ThinQ to Diagnose Issues

If you experience a problem with your Wi-Fi equipped appliance, it can transmit troubleshooting data to a smartphone using the **LG ThinQ** application.

- Launch the **LG ThinQ** application and select the **Smart Diagnosis** feature in the menu. Follow the instructions provided in the **LG ThinQ** application.

Using Audible Diagnosis to Diagnose Issues

Follow the instructions below to use the audible diagnosis method.

- Launch the **LG ThinQ** application and select the **Smart Diagnosis** feature in the menu. Follow the instructions for audible diagnosis provided in the **LG ThinQ** application.

- 1** Plug the power plug in the outlet properly.
- 2** Place the mouthpiece of your smartphone close to the appliance.
- 3** Select **Smart Diagnosis** with the remote control. → See **Additional Features and Settings(Smart Diagnosis)**.
 - Keep the smartphone in place until the data transfer has finished.
- 4** After the data transfer is complete, the diagnosis will be displayed in the application.

NOTE

- For best results, do not move the phone while the tones are being transmitted.
- Be sure to keep ambient noise to a minimum or the phone may not correctly receive the buzzer beeps from the indoor unit.

MAINTENANCE

Cleaning Function

Using Auto Clean+ Function

In the Cooling and Dehumidification modes, moisture is generated inside the indoor unit. You can reduce that moisture.

1 Turn the appliance on.

2 Press the **Function** button.

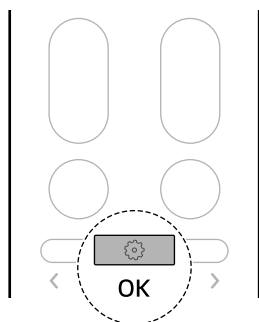

3 Press the < or > button to select **Auto Clean+** and then press the **Function** button.

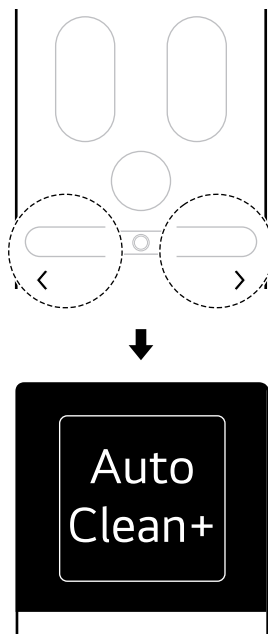

4 Press the < or > button to select the desired settings and then press the **Function** button. Setup is complete.

- Each time you press the < or > button, it changes in the order of **Stop** ↔ **On** ↔ **Off** ↔ **Back**.

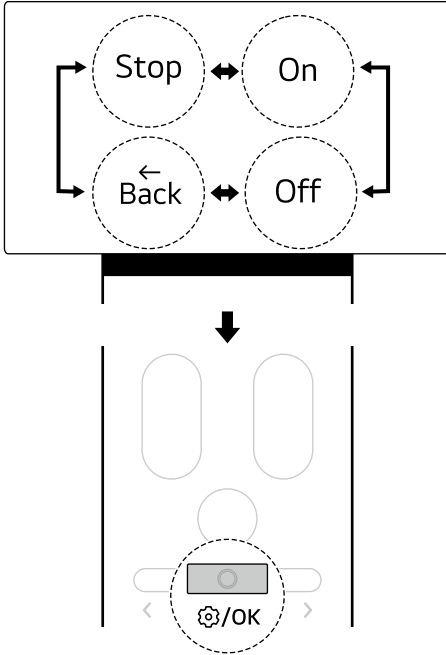

- You can check the Auto Clean+ function setting status on the indoor unit display.

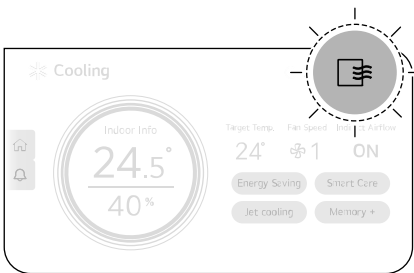

NOTE

- When you use the appliance for the first time, the Auto Clean+ function is set. If you don't want to use Auto Clean+ function, turn it off.
- The Auto Clean+ time is automatically set according to the appliance usage conditions. The remaining time is displayed on the indoor unit.

- The Auto Clean+ time is up to 25 minutes.
- Once the Auto Clean+ function is set, the previously set Auto Clean+ function will be maintained when the appliance is used again.
- If the appliance will not be used for a long period of time, run the fan mode for more than 1 hour to completely dry the inside of the appliance before storing it.
- You can set the Auto Clean+ function even when the appliance is not operating.

Using Freeze Cleaning Function

Contaminants such as dust are reduced by repeating the process of freezing and thawing the heat exchanger inside the appliance. If On and Off Timer is set, disable the schedule function and then use the Freeze Cleaning function. → See **Additional Features and Settings(Cancel all Timer)**.

1 Turn the appliance on.

2 Press the **Function** button.

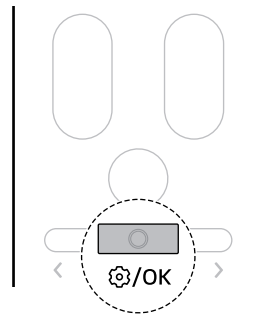

- 3 Press the < or > button to select **Freeze Cleaning** and then press the **Function** button.

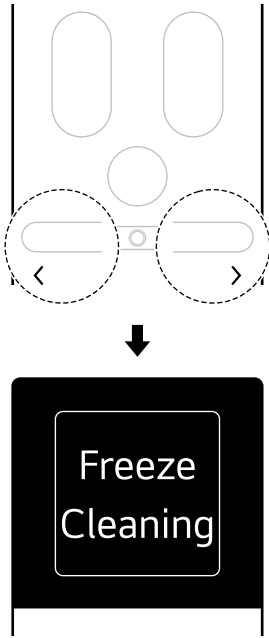

- Each time you press the < or > button, the settings change in the order of **Start** ↔ **Stop** ↔ **Back**.

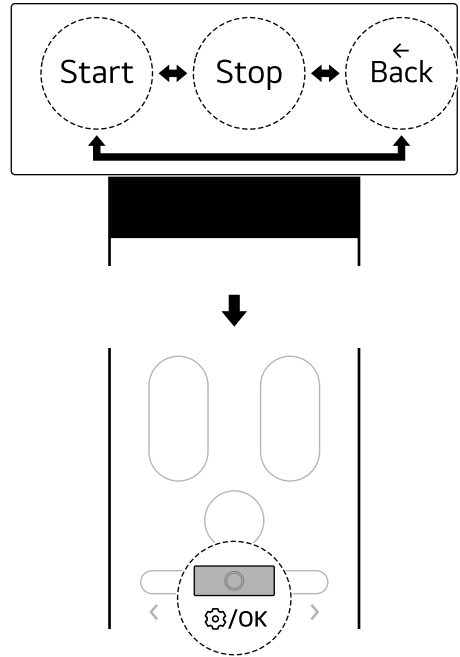

- 4 Press the < or > button to select the desired settings and then press the **Function** button. Setup is complete.

NOTE

- When the Freeze Cleaning function starts, the progress status is displayed from 0% to 100% on the indoor unit display.
- The Freeze Cleaning function ends after the heat exchanger is fully dried.
- The Freeze Cleaning function can be used even when the appliance is operating.
- When the Freeze Cleaning function operates, cold air comes out from the air outlet.
- If the indoor humidity is high when the Freeze Cleaning function is activated, the area around the indoor unit may appear hazy, as if there is smoke or fog.
- If you press the Power button on the appliance or remote control during Freeze Cleaning, the Freeze Cleaning function will be disabled.

- During Freeze Cleaning, the appliance may contract or expand, making a “tick-tick” or “click-tick” noise.
- After cleaning the heat exchanger, the appliance automatically turns off and operates in cooling mode when turned on again.
- If the reservation function is set, the Freeze Cleaning function may not work properly.
- The Freeze Cleaning function can be used indoors at 21°C~32°C and outdoors at 21°C~37°C. Since the heat exchanger cleaning function is a hygiene management function, not a cooling function, the conditions for use are different from the appliance’s cooling guarantee temperature.
- If you operate the Freeze Cleaning function at a temperature outside 21°C ~32 °C indoors or 21 °C~37 °C outdoor, the beep sound will sound 5 times and the function will not work.
- The Freeze Cleaning function can be set even when the appliance is not operating.

Cleaning

WARNING

- Before cleaning or performing maintenance, disconnect the power supply and wait until the fan stops.

Cleaning Interval

Cleaning the Appliance

If the appliance will not be used for an extended period of time, dry the appliance to maintain it in the best condition. Clean the appliance regularly to maintain optimal performance and to prevent possible breakdown.

- Dry the appliance in Fan mode for 3 to 4 hours and disconnect the power. There may be internal damage if moisture is left in the appliance's components.
- Before using the appliance again, dry the components inside the appliance in Fan mode for 3 to 4 hours. This will help to reduce the odour generated from moisture.

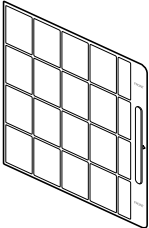
Type	Image	Interval
Air filter		<ul style="list-style-type: none"> • Clean with a vacuum or hand wash. • 2 weeks

! CAUTION

- Before removing the filter from the appliance, turn off the appliance and pull out the power plug or turn off the main power switch.
- Do not forcibly separate or assemble the filter. Doing so may damage the filter.
- After cleaning the filter, install the filter properly before operating the appliance.
 - If the filter is not installed, dust or foreign substances may enter the indoor unit and cause appliance failure.

NOTE

- If you continue to use the filter without thoroughly cleaning it according to the cleaning cycle, the appliance may emit an odour. When using the appliance in a dusty environment, clean the filter more often than the regular interval.
- If there is a lot of contaminants such as dust or if the filter is damaged, replace it with a new one.
- Contact the LG Electronics service centre when filter replacement is required. The cost of filter replacement or cleaning through the LG Electronics service centre is the responsibility of the consumer regardless of the warranty period.
- Depending on the model, filter components or shapes may differ.

Cleaning the Air Filter

Clean the air filter once every 2 weeks, or more if needed.

Removing the Air Filter

- 1 Turn the appliance off.
- 2 Pull the top part of the front panel forward to open it, then grab the filter handle and pull it to the side to completely remove the filter.

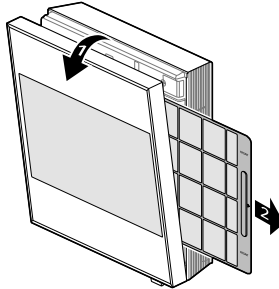

⚠ CAUTION

- When removing the filter, be careful not to scratch the appliance or bend the filter.

Cleaning the Air Filter

- 1 Take the air filter out of the appliance.
- 2 When there are few contaminants in the air filter, wash the filter under running water. If there are a lot of contaminants such as dust in the air filter, soak the filter in water with neutral detergent and then wash it.

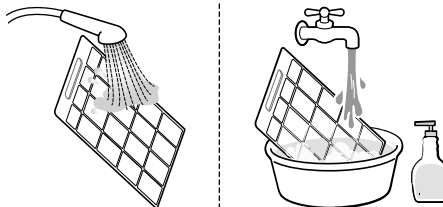

- 3 Dry the air filter in the shade.

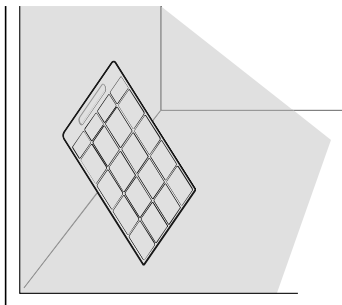

Mounting the Air Filter

- Insert the air filter into the filter hanger, then close the front panel by pressing it by hand.

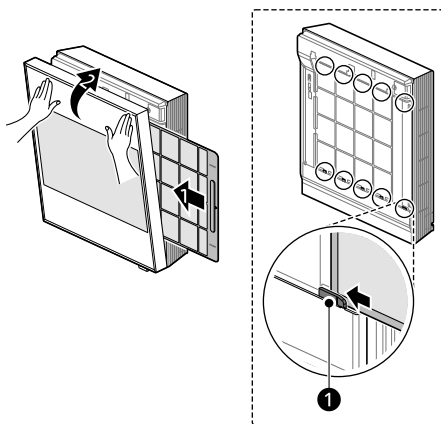

- 1 Filter Hanger

NOTE

- If the front panel does not close completely, press the **Power** button on the remote control to turn on the appliance, then turn it off again to close the front panel completely.
-

Cleaning the Fan

Clean the fan inside the appliance.

Disassemble the Appliance

- 1 Turn the appliance off.

- 2** Remove the lower frame attached to the bottom of the front panel.

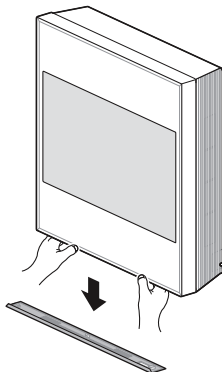

- 3** Pull the front panel slightly forward and lift it up, and then hook the Front Panel Hook onto the Bottom Panel Hanger(Top).

- Check that the three hooks on the front panel are properly positioned in the three places on the upper part of the bottom panel.

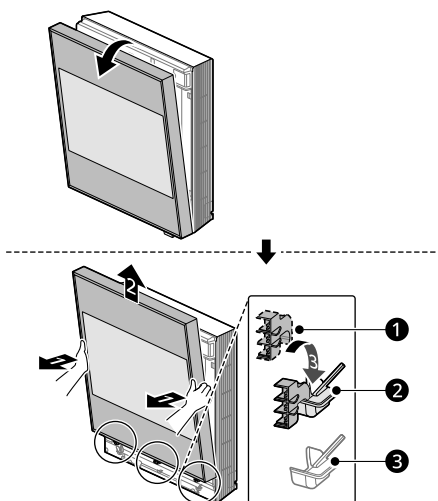

- ① Front Panel Hook
- ② Bottom Panel Hanger(Top)
- ③ Bottom Panel Hanger(Bottom)

- 4 Loosen the two screws that secure the lower grill, then hold the upper part of the lower grill and pull it forward to remove it.

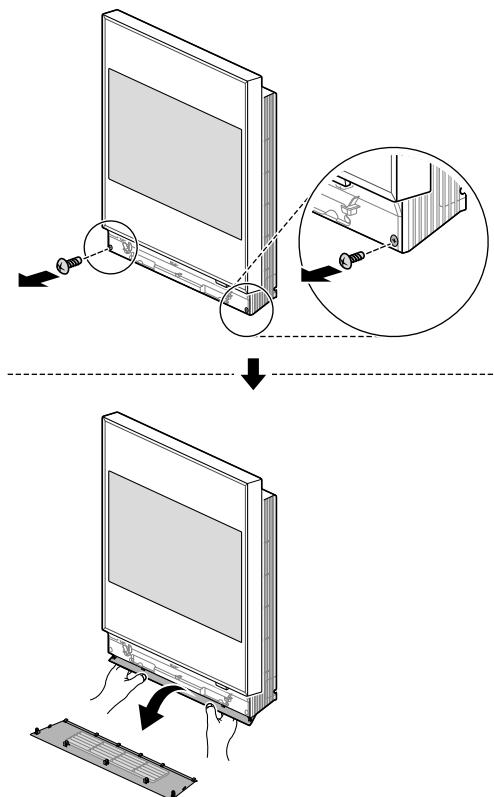

Cleaning the Fan

- Use a cleaning tool, such as a duster, to clean the fan or the area around it.

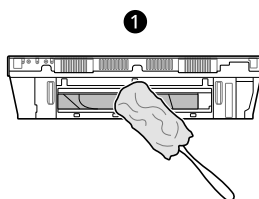

- 1 Bottom Part of the Appliance

! CAUTION

- When cleaning the fan, do not use flammable substances (alcohol, thinner, benzene, etc.), toothpaste, abrasives, etc., but clean with a soft cloth.

- When cleaning the fan, wear gloves and be careful to avoid injury from sharp parts (heat exchanger, etc.).

NOTE

- For safety reasons, the appliance may not operate if it is not fully assembled. Completely assemble the appliance.
- If the front panel does not close completely, press the Power button on the remote control to turn on the appliance, then turn it off again to close the front panel completely.

Assemble the Appliance

- 1 Turn the appliance off.
- 2 Insert the Bottom Grill Hangers and Bottom Grill Hooks into the grooves on the bottom of the indoor unit body, then press the lower grill hooks with your hand until it clicks to completely close the lower grill.

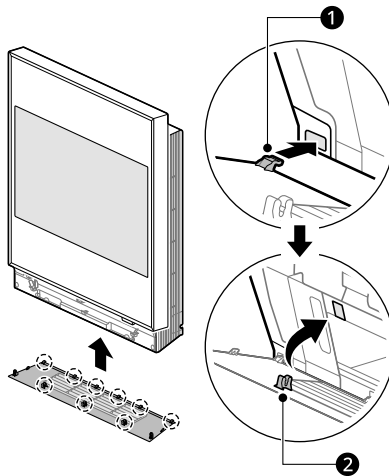

① Bottom Grill Hangers(6 Pieces)

② Bottom Grill Hooks(3 Pieces)

- 3** Secure the lower grill with two screws.

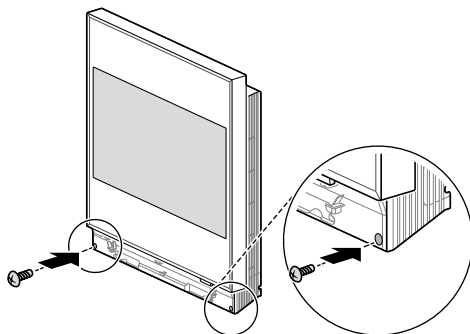

- 4** Pull the front panel slightly forward and lift it up, and then hook the Front Panel Hook onto the Bottom Panel Hanger(Bottom).

- Check that the three front panel hooks are properly positioned in the three locations on the lower part of the bottom panel.

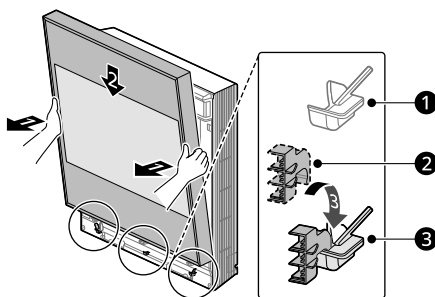

- ① Bottom Panel Hanger (Top)
- ② Front Panel Hook
- ③ Bottom Panel Hanger (Bottom)

- 5 Close the front panel by pressing it with your hand.

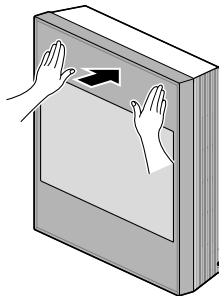

- 6 Attach the lower frame to the bottom of the front panel, then press both ends of the lower frame with your hands until they click into place.

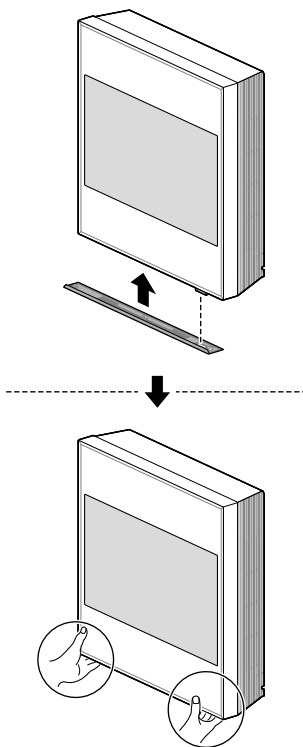

⚠ CAUTION

- Do not forcibly separate or assemble the appliance. Doing so may damage the appliance.

⚠ CAUTION

- Do not forcibly press down on both ends of the lower frame. Doing so may damage the slots in the lower frame.

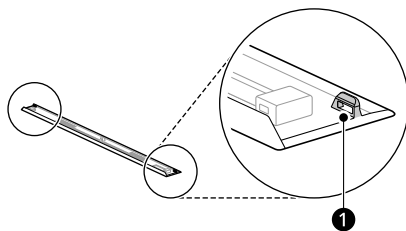

1 Slots in Lower Frame

NOTE

- For safety reasons, the appliance may not operate if it is not fully assembled. Completely assemble the appliance.
 - If the front panel does not close completely, press the **Power** button on the remote control to turn on the appliance, then turn it off again to close the front panel completely.
-

TROUBLESHOOTING

Before Calling for Service

Please check the following before you contact the service centre. If the problem persists, contact your local service centre.

NOTE

- Some functions may not be supported, depending on the model.

Self-Diagnosis Function

This appliance has a built-in **self-diagnosis** function. If an error occurs, the lamp of the indoor unit will flash in 2-second intervals. If this occurs, contact your local dealer or service centre.



Operation

Symptoms	Possible Cause & Solution
The appliance does not work normally.	Burning smell and strange sounds are coming from the appliance. <ul style="list-style-type: none"> • Turn off the appliance, switch off or disconnect the power supply, and contact the service centre.
	Water leaks from the indoor unit even when the humidity level is low. <ul style="list-style-type: none"> • Turn off the appliance, switch off or disconnect the power supply, and contact the service centre.
	The power cable is damaged or it is generating excessive heat. <ul style="list-style-type: none"> • Turn off the appliance, switch off or disconnect the power supply, and contact the service centre.
	A switch, a circuit breaker (safety, ground) or a fuse is not operating properly. <ul style="list-style-type: none"> • Turn off the appliance, switch off or disconnect the power supply, and contact the service centre.
	The appliance generates an error code from its self-diagnosis. <ul style="list-style-type: none"> • Turn off the appliance, switch off or disconnect the power supply, and contact the service centre.
The fan speed cannot be adjusted.	The Jet mode is selected. <ul style="list-style-type: none"> • In some operating modes, you cannot adjust the fan speed. Select an operating mode in which you can adjust the fan speed.
The temperature cannot be adjusted.	The Fan mode or Jet mode is selected. <ul style="list-style-type: none"> • In some operating modes, you cannot adjust the temperature. Select an operating mode in which you can adjust the temperature.

Symptoms	Possible Cause & Solution
The appliance stops during operation.	The appliance is suddenly turned off. <ul style="list-style-type: none"> The Off Timer function may have timed out, which turns the appliance off. Check the timer settings.
	A power failure has occurred during operation. <ul style="list-style-type: none"> Wait for the power to come back on. If you have the Auto Restart function enabled, your appliance will resume its last operation several minutes after power is restored.
The appliance does not work.	The appliance is unplugged. <ul style="list-style-type: none"> Check whether the power cord is plugged into the outlet or the power isolators are switched on.
	A fuse exploded or the power supply is blocked. <ul style="list-style-type: none"> Replace the fuse or check if the circuit breaker has tripped.
	A power failure has occurred. <ul style="list-style-type: none"> Turn off the appliance when a power failure occurs. When the power is restored, wait 3 minutes, and then turn on the appliance.
	The voltage is too high or too low. <ul style="list-style-type: none"> Check if the circuit breaker has tripped.
	The appliance was turned off automatically at a preset time. <ul style="list-style-type: none"> Turn the appliance on.
	The battery setting in the wireless remote control is incorrect. <ul style="list-style-type: none"> Make sure that the batteries are inserted correctly in your wireless remote control. If the batteries are placed correctly, but the appliance still does not operate, replace the batteries and try again.
The appliance does not emit cool air.	Air is not circulating properly. <ul style="list-style-type: none"> Make sure that there are no curtains, blinds, or pieces of furniture blocking the front of the appliance.
	The air filter is dirty. <ul style="list-style-type: none"> Clean the air filter once every 2 weeks. See “Cleaning the Air Filter” for more information.
	The room temperature is too high. <ul style="list-style-type: none"> In summer, it may take some time to cool down the indoor sufficiently. In this case, select the Jet Cooling mode to cool down the indoor quickly.
	Cold air is escaping from the room. <ul style="list-style-type: none"> Make sure that no cold air is escaping through the ventilation points in the room.

Symptoms	Possible Cause & Solution
The appliance does not emit cool air.	The desired temperature is higher than the current temperature. <ul style="list-style-type: none"> Set the desired temperature to a level lower than the current temperature.
	There is a heating source nearby. <ul style="list-style-type: none"> Avoid using heat generators like electric ovens or gas hobs while the air conditioner is in operation.
	Fan mode is selected. <ul style="list-style-type: none"> During Fan mode, air blows from the appliance without cooling or heating the indoor air. Switch the operating mode to cooling operation.
	Outside temperature is too high. <ul style="list-style-type: none"> The cooling effect may not be sufficient.

Display

Symptoms	Possible Cause & Solution
I turned the power on, but nothing appears on the appliance screen.	Did you set the screen to off? <ul style="list-style-type: none"> Press and hold the  button on the remote control for 3 seconds to turn on the product screen.
The pointer speed of the remote control is too slow or fast.	Have you adjusted the pointer speed on your remote control? <ul style="list-style-type: none"> Press the  button at the bottom of the home screen and adjust in System > Language & Input > Pointer Speed.
I see spots on the screen.	Is the appliance screen an LCD panel? <ul style="list-style-type: none"> While using the appliance, several pixel spots (red, green, blue, white, black) may appear on the screen. This phenomenon can be seen due to the characteristics of the LCD panel and has nothing to do with the performance of the monitor. This is not a malfunction, so use it with confidence.
Even if you change the screen, an afterimage of the previous screen remains.	Have you kept the same screen for a long time? <ul style="list-style-type: none"> If you leave the same screen on for a long time, an afterimage of the previous screen may remain even when you change the screen. Press and hold the  button on the remote control for 3 seconds to turn the appliance's screen off and then on. The afterimage of the previous screen disappears.
The screen is too bright or dark so I can't see it well.	Have you adjusted the screen brightness? <ul style="list-style-type: none"> Set the screen brightness by pressing the Screen Brightness button at the bottom of the home screen using the remote control.

Symptoms	Possible Cause & Solution
The cover screen changes to a clock screen.	<p>Have you turned on night vision mode?</p> <ul style="list-style-type: none"> When you set the night clock mode, the cover screen screen changes to the clock screen for the set time. If you do not want to use the night vision mode, press the  button at the bottom of the home screen and turn off the night vision mode in the cover screen item.

Performance

Symptoms	Possible Cause & Solution
The indoor unit is still operating even when the appliance has been turned off.	<p>The Auto Clean+ function is being operated.</p> <ul style="list-style-type: none"> Allow the Auto Clean+ function to continue since it reduces any remaining moisture inside the indoor unit. If you do not want this function, you can turn the indoor unit off.
The air outlet on the indoor unit is discharging mist.	<p>The cold air from the appliance makes mist.</p> <ul style="list-style-type: none"> When the room temperature decreases, this phenomenon will disappear.
Water leaks from the outdoor unit.	<p>In the heating operations, condensed water drops from the heat exchanger.</p> <ul style="list-style-type: none"> This requires that a drain hose should be installed under the base pan. Contact the installer.
There is noise or vibration.	<p>A clicking sound can be heard when the appliance starts or stops due to movement of the reversing valve.</p> <p>Creaking sound: The plastic parts of the indoor unit creak when they shrink or expand due to sudden temperature changes.</p> <p>Flowing or blowing sound: This is the flow of refrigerant through the appliance.</p> <ul style="list-style-type: none"> Noise is normal during or after operation. It is not a sign of malfunction.
The indoor unit gives off an odour.	<p>Odour (such as cigarette smoke) may be absorbed into the indoor unit and discharged with airflow.</p> <ul style="list-style-type: none"> If the smell does not disappear, you need to wash the filter. If this does not work, contact the service centre to clean your heat exchanger.
The appliance does not emit warm air.	<p>When the Heating mode starts, the vane is almost closed, and no air comes out, even though the outdoor unit is operating.</p> <ul style="list-style-type: none"> This is normal. Please wait until the appliance has generated enough warm air to blow through the indoor unit.
	<p>The outdoor unit is in Defrosting mode.</p> <ul style="list-style-type: none"> In Heating mode, ice and frost is built up on the coils when the outside temperature falls. The Defrosting mode reduces a layer of frost on the coil, and it should finish in approximately 15 minutes.

Symptoms	Possible Cause & Solution
The appliance does not emit warm air.	Outside temperature is too low. <ul style="list-style-type: none"> The heating effect may not be sufficient.

Wi-Fi

Symptoms	Possible Cause & Solution
Your home appliance and smartphone are not connected to the Wi-Fi network.	The password for the Wi-Fi that you are trying to connect to is incorrect. <ul style="list-style-type: none"> Find the Wi-Fi network connected to your smartphone and remove it, then register your appliance on LG ThinQ.
	Mobile data for your smartphone is turned on. <ul style="list-style-type: none"> Turn off the Mobile data of your smartphone and register the appliance using the Wi-Fi network.
	The wireless network name (SSID) is set incorrectly. <ul style="list-style-type: none"> The wireless network name (SSID) should be a combination of English letters and numbers. (Do not use special characters.)
	The router frequency is not 2.4 GHz. <ul style="list-style-type: none"> Only a 2.4 GHz router frequency is supported. Set the wireless router to 2.4 GHz and connect the appliance to the wireless router. To check the router frequency, check with your Internet service provider or the router manufacturer.
	The distance between the appliance and the router is too far. <ul style="list-style-type: none"> If the distance between the appliance and the router is too far, the signal may be weak and the connection may not be configured correctly. Move the location of the router so that it is closer to the appliance.

